



GUAM POWER AUTHORITY

ATURIDÁT ILEKTRESEDÁT GUÅHAN
P.O.BOX 2977 • HAGÁTÑA, GUAM U.S.A. 96932-2977

To All Interested Parties:

The Guam Power Authority, Procurement Office will continue its efforts with improvement towards accountability, transparency, and efficiency to better serve GPA personnel, prospective bidders, and guests, please be advised of the following:

1. Prospective bidders are notified that all sealed bid submissions shall be inclusive of one (1) original, two (2) copies and delivered on or before the date and time for bid opening via hand delivered, delivered by mail, or delivered by other courier service to:

ISSUING OFFICE:

Guam Power Authority-Procurement Office
 1st. Floor, Room 101
 Gloria B. Nelson Public Service Building
 688 Route 15
 Mangilao, Guam 96913

2. Prospective bidders are notified that within this IFB packet, if applicable, is the Form of Contract. All inquiries must be submitted during the solicitation period and prior to the closing date. Any inquiries received after the closing date and prior to award shall not be considered.

All inquiries and communications shall be directed to the GPA Procurement Division;

- a. Tel: (671) 648-3045 and/or (671) 648-3055
- b. Email: GPA-Interested-Parties@gpagwa.com

3. Prospective bidders will be notified via Email of all Issued Amendments and directed to the GPA Procurement/Materials Management Available Tenders Webpage listed below to download a copy, which will serve as your company's acknowledgement of Issued Amendment(s).

- a. https://notices.guam.gov/notices?view=list&keyword=&date_from=&date_to=&type_id=&event_date_from=&event_date_to=&department_id=&division_id=&topic_id=&topic_id%5B%5D=59&topic_id%5B%5D=62&group_id=&deadline=0&show_records=10#notices_start#notices_start
- b. <https://guampowerauthority.com/>
- c. https://go.opengovguam.com/tenders/tenders_list-standalone/gpa?tender_status=Available

COMPANY NAME:

REPRESENTATIVE NAME:

Print / Sign Date

BID NO.: GPA-047-26

RFP NO.: _____



Frances E. Santos
Chairman



JOHN M. BENAVENTE, P.E.
General Manager

Telephone Nos. (671) 648-3045/55 or Facsimile (671) 648-3165

Accountability	Impartiality	Competence	Openness	Value
INVITATION FOR BID (IFB) NO.: GPA-047-26				
DESCRIPTION: Pad Mounted Transformers				

SPECIAL REMINDERS TO PROSPECTIVE BIDDERS

Bidders are reminded to read the Sealed Bid Solicitation and Instructions, and General Terms and Conditions attached to the IFB to ascertain that all of the following requirements checked below are submitted in the bid envelope, **one (1) original, two (2) copies**, at the date and time for bid opening. All sealed proposal submissions must be hand delivered, delivered by mail, or delivered by other courier service to:

ISSUING OFFICE:

Guam Power Authority-Procurement Office
1st. Floor, Room 101
Gloria B. Nelson Public Service Building
688 Route 15
Mangilao, Guam 96913

(XX) BID GUARANTEE – (15%) May be in the form of:
Reference #11 on the General Terms and Conditions

- a. Cashier's Check or Certified Check (NOTE: Cashier's Check or Certified Check Refunds will be **ONLY be made out to the name of the Bidder.**)
- b. Letter of Credit or
- c. Bid Bond – Valid only if accompanied by:
 - 1. Current Certificate of Authority issued by the Insurance Commissioner; or
 - 2. Power of Attorney issued by the Surety to the Resident General Agent or the following:
 - a. Current Sworn Annual Report (Limited Liability Company (LLC) and/or Corporation) or;
 - b. Current Renewal of Annual Limited Liability Partnership (LLP); or
 - 3. Power of Attorney issued by two (2) major officers of the Surety to whomever is signing on their behalf.

- () STATEMENT OF QUALIFICATION;
- () SAMPLES;
- (XX) BROCHURES/DESCRIPTIVE LITERATURE; (Shall provide detailed literature on items offered)
- (XX) OWNERSHIP AND INTEREST DISCLOSURE AFFIDAVIT; *Pursuant to Public Law 36-13; 5 GCA §5233(a)*
- (XX) NON-COLLUSION AFFIDAVIT;
- (XX) NO GRATUITIES OR KICKBACKS AFFIDAVIT;
- (XX) ETHICAL STANDARDS AFFIDAVIT;
- (XX) WAGE DETERMINATION AFFIDAVIT;
- (XX) RESTRICTIONS AGAINST SEX OFFENDERS AFFIDAVIT
- (XX) CONTINGENT FEES AFFIDAVIT;

Note: The above Affidavits must comply with the following requirements:

- a. The affidavit must be signed within 60 days on or before the date the bid is due;
- b. Date of signature of the person authorized to sign the bid and the notary date must be the same.
- c. First time affidavit **must** be an **original** – If copy, indicate Bid Number/Agency where original can be obtained.

(XX) OTHER REQUIREMENTS:
A Guam Business License and/or Contractor's License with proof of Employer Identification Number (EIN) is not required in order to provide a proposal for this engagement, but is a pre-condition for entering into a contract with the Authority.

This page must be signed and returned in the bid envelope together with the bid. Failure to comply with the above requirements will mean a disqualification and rejection of the bid.

On this _____ day of _____, 2026, I, _____, authorized representative of _____ acknowledge receipt of this special reminder to prospective bidders with the above referenced IFB.

Bidder Representative's Signature

INVITATION FOR BID NO.: GPA-047-26
Requisition No.: 40989

NO.	DESCRIPTION	QTY:	U/I:	UNIT PRICE:	TOTAL PRICE:
1.0	75 kVA Pad Mounted Transformer	4	Each	\$ _____	\$ _____

Comply **Non Comply**

Comply must be identified below.
 All deviations must be identified below.

A. SPECIFICATIONS:

- A.1 - Three-Phase, Dead-Front, 3 Bushing Radial Feed, Insulation Class 15 kV, BIL 95 kV, External Tap Changer, External Load Break Oil Rotary Switch (LBOR) Primary Voltage 13.8 kV, Secondary Voltage 120/208 V. _____
- A.2 - All parts of the transformer such as hood, doors, hinges, tank, compartment, base, radiator, and other accessories shall be made of type 304L stainless steel. _____
- A.3 - 15kV, 200A load break bushing wells and inserts shall be provided, neutral grounding strap, captive pent ahead bolt, LV door 3-point latching, HV door secured separately and only accessible after opening LV door, ground pads in HV and LV compartments provided with lugs/nuts for #4 to #10 copper wire. _____

As per GPA Specifications No.: E-004, Revision 10
 GPA Index No.: E4007513802020B-3

B. SAFETY DATA SHEET (SDS):

- B.1 - For the procurement of all chemicals, the awarded vendor shall have the accompanying Safety Data Sheet (SDS), in line with the Globally Harmonized System (GHS) for Classification and Labeling of Chemicals, electronically submitted to the Authority's Safety Division via email attention to: sds@gpagwa.com prior to its delivery _____
- B.2 - A hard copy of awarded SDS is required to accompany all chemicals upon official delivery onto the Authority property. _____

C. LOSS EVALUATION:

- C.1 - Bid award for pad mounted transformers shall be based on the Total Cost of Ownership (TCO) and all other requirements as specified in GPA Specification E-004, Revision 10, Section 6. _____

D. MARKING REQUIREMENTS:

- D.1 - Stencil 1" GPA Index No./ Purchase Order No./ Bid No./ Serial No. and Date of MFG. (DO NOT OBLITERATE MFG LABEL) _____
- D.2 - Manufacturer Serial No. shall be shown on all delivery receipts and invoices. _____
- D.3 - All transformers shall have a weather resistant decal certifying NON-PCB. _____
- D.4 - Vendors are to provide a user's manual and certified laboratory test report for every transformer delivered. _____
- D.5 - Vendors are responsible to de-van materials from containers. _____
- D.6 - Vendors are responsible to provide a means to off load transformers that are 750 kVA or larger. _____
- D.7 - Transformers shall meet all U.S. Department of Energy requirements. _____
- D.8 - Transformer shall be placed and crated with suitable materials to prevent damage and injury during shipment and handling operations. _____

E. SUBMITTALS:

- E.1 - The bidder shall provide with the following data with their bid submittal:
 - a. Nameplate Data _____
 - b. Connection Diagrams _____
 - c. Guaranteed full load loss at 100% voltage and load _____
 - d. Guaranteed no-load loss at rated voltage _____
 - e. Shop Drawings _____

f. Completed Appendix A – Pad Mounted Transformer Information Sheet

E.2 - Information for initial bid review shop drawings shall include:

- a. Mounting dimensions
- b. Location of equipment, devices and terminals
- c. Estimated Weight
- d. Estimated number of gallons of oil
- e. Sample Nameplate Data
- f. Connection diagrams
- g. Guaranteed Full load loss at 100% voltage and load
- h. Guaranteed No-Load Loss at Rated Voltage

E.3 – The transformer shall withstand the following environmental tests for 2000 hours:

- a. ASTM B117, Standard Method of Salt Spray (Fog) Testing.

E.4 – Vendor shall comply with GPA E-004, Revision 10 Page 20 of 20 Appendix A Pad Mounted Transformer Information Sheet.

- a. Kindly complete the product information and provided the required documents. Incomplete information shall be cause for rejection.

****APPROVED EQUAL TO OR BETTER****

All deviations shall be identified referencing the Section and Sub-Section(s) from the attached GPA Specification.

NOTE:

Bidders must state either “Comply” or “Not Comply” against each specification on the bid document.

NOTE:

Not withstanding the fact that this contract was written by one (1) party, it will be construed that is was written by two (2) parties.

REMARKS / DEVIATIONS:

DELIVERY REQUIREMENT:

18 Weeks After Approved Drawings by Guam Power Authority

Reasonable delivery extension requests for this specific bid will be duly considered with the supporting manufacturer documentation however, such request are not guaranteed approval due to critical and urgent need of the materials to support the Guam Power Authority's needs.

Specifications Generated/Reviewed by:

TO BE COMPLETED BY BIDDER:

Angela Balajadia 04/28/2026
 ANGELA BALAJADIA Date
 Inventory Management Officer

MANUFACTURER/BRAND NAME: _____

CAT. NO. / MODEL NO.: _____

Specifications Reviewed by:

PLACE OF ORIGIN: _____

Louis C. Camacho P.E. 4/27/2026
 LOUIS C. CAMACHO, P.E. Date
 Engineering Supervisor

EXPORT ABROAD: _____

TIME OF DELIVERY AFTER APPROVED DRAWINGS BY GUAM POWER AUTHORITY: _____

Specifications Approved by:

Beatrice P. Limtiaco 4/28/2026
 BEATRICE P. LIMTIACO Date
 Assistant General Manager of Administration

INVITATION FOR BID NO.: GPA-047-26
Requisition No.: 40989

NO.	DESCRIPTION	QTY:	U/I:	UNIT PRICE:	TOTAL PRICE:
2.0	150 kVA Pad Mounted Transformer	2	Each	\$ _____	\$ _____

Comply **Non Comply**

Comply must be identified below.
 All deviations must be identified below.

A. SPECIFICATIONS:

- A.1 - Three-Phase, Dead-Front, 3 Bushing Radial Feed, Insulation Class 15 kV, BIL 95 kV, External Tap Changer, External Load Break Oil Rotary Switch (LBOR) Primary Voltage 13.8 kV, Secondary Voltage 120/208 V. _____
- A.2 - All parts of the transformer such as hood, doors, hinges, tank, compartment, base, radiator, and other accessories shall be made of type 304L stainless steel. _____
- A.3 - 15kV, 200A load break bushing wells and inserts shall be provided, neutral grounding strap, captive pent ahead bolt, LV door 3-point latching, HV door secured separately and only accessible after opening LV door, ground pads in HV and LV compartments provided with lugs/nuts for #4 to #10 copper wire. _____

As per GPA Specifications No.: E-004, Revision 10
 GPA Index No.: E4015013802020B-3

B. SAFETY DATA SHEET (SDS):

- B.1 - For the procurement of all chemicals, the awarded vendor shall have the accompanying Safety Data Sheet (SDS), in line with the Globally Harmonized System (GHS) for Classification and Labeling of Chemicals, electronically submitted to the Authority's Safety Division via email attention to: sds@gpagwa.com prior to its delivery _____
- B.2 - A hard copy of awarded SDS is required to accompany all chemicals upon official delivery onto the Authority property. _____

C. LOSS EVALUATION:

- C.1 - Bid award for pad mounted transformers shall be based on the Total Cost of Ownership (TCO) and all other requirements as specified in GPA Specification E-004, Revision 10, Section 6. _____

D. MARKING REQUIREMENTS:

- D.1 - Stencil 1" GPA Index No./ Purchase Order No./ Bid No./ Serial No. and Date of MFG. (DO NOT OBLITERATE MFG LABEL) _____
- D.2 - Manufacturer Serial No. shall be shown on all delivery receipts and invoices. _____
- D.3 - All transformers shall have a weather resistant decal certifying NON-PCB. _____
- D.4 - Vendors are to provide a user's manual and certified laboratory test report for every transformer delivered. _____
- D.5 - Vendors are responsible to de-van materials from containers. _____
- D.6 - Vendors are responsible to provide a means to off load transformers that are 750 kVA or larger. _____
- D.7 - Transformers shall meet all U.S. Department of Energy requirements. _____
- D.8 - Transformer shall be placed and crated with suitable materials to prevent damage and injury during shipment and handling operations. _____

E. SUBMITTALS:

- E.1 - The bidder shall provide with the following data with their bid submittal:
 - a. Nameplate Data _____
 - b. Connection Diagrams _____
 - c. Guaranteed full load loss at 100% voltage and load _____
 - d. Guaranteed no-load loss at rated voltage _____
 - e. Shop Drawings _____

f. Completed Appendix A – Pad Mounted Transformer Information Sheet

E.2 - Information for initial bid review shop drawings shall include:

- a. Mounting dimensions
- b. Location of equipment, devices and terminals
- c. Estimated Weight
- d. Estimated number of gallons of oil
- e. Sample Nameplate Data
- f. Connection diagrams
- g. Guaranteed Full load loss at 100% voltage and load
- h. Guaranteed No-Load Loss at Rated Voltage

E.3 – The transformer shall withstand the following environmental tests for 2000 hours:

- a. ASTM B117, Standard Method of Salt Spray (Fog) Testing.

E.4 – Vendor shall comply with GPA E-004, Revision 10 Page 20 of 20 Appendix A Pad Mounted Transformer Information Sheet.

- a. Kindly complete the product information and provided the required documents. Incomplete information shall be cause for rejection.

****APPROVED EQUAL TO OR BETTER****

All deviations shall be identified referencing the Section and Sub-Section(s) from the attached GPA Specification.

**NOTE:
Bidders must state either “Comply” or “Not Comply” against each specification on the bid document.**

NOTE:
Not withstanding the fact that this contract was written by one (1) party, it will be construed that is was written by two (2) parties.

REMARKS / DEVIATIONS:

DELIVERY REQUIREMENT:
24 Weeks After Approved Drawings by Guam Power Authority

Reasonable delivery extension requests for this specific bid will be duly considered with the supporting manufacturer documentation however, such request are not guaranteed approval due to critical and urgent need of the materials to support the Guam Power Authority's needs.

Specifications Generated/Reviewed by:

TO BE COMPLETED BY BIDDER:

Angela Balajadia 04/28/2026
 ANGELA BALAJADIA Date
 Inventory Management Officer

MANUFACTURER/BRAND NAME: _____

CAT. NO. / MODEL NO.: _____

Specifications Reviewed by:

PLACE OF ORIGIN: _____

Louis C. Camacho P.E. 4/27/2026
 LOUIS C. CAMACHO, P.E. Date
 Engineering Supervisor

EXPORT ABROAD: _____

TIME OF DELIVERY AFTER APPROVED DRAWINGS BY GUAM POWER AUTHORITY: _____

Specifications Approved by:

Beatrice P. Limtiaco 4/28/2026
 BEATRICE P. LIMTIACO Date
 Assistant General Manager of Administration

INVITATION FOR BID NO.: GPA-047-26
Requisition No.: 40989

NO.	DESCRIPTION	QTY:	U/I:	UNIT PRICE:	TOTAL PRICE:
3.0	750 kVA Pad Mounted Transformer	6	Each	\$ _____	\$ _____

Comply **Non Comply**

Comply must be identified below.
 All deviations must be identified below.

A. SPECIFICATIONS:

- A.1 - Three-Phase, Dead-Front, 3 Bushing Radial Feed, Insulation Class 15 kV, BIL 95 kV, External Tap Changer, External Load Break Oil Rotary Switch (LBOR) Primary Voltage 13.8 kV, Secondary Voltage 120/208 V. _____
- A.2 - All parts of the transformer such as hood, doors, hinges, tank, compartment, base, radiator, and other accessories shall be made of type 304L stainless steel. _____
- A.3 - 15kV, 200A load break bushing wells and inserts shall be provided, neutral grounding strap, captive pent ahead bolt, LV door 3-point latching, HV door secured separately and only accessible after opening LV door, ground pads in HV and LV compartments provided with lugs/nuts for #4 to #10 copper wire. _____

As per GPA Specifications No.: E-004, Revision 10
 GPA Index No.: E4075013802020B-3

B. SAFETY DATA SHEET (SDS):

- B.1 - For the procurement of all chemicals, the awarded vendor shall have the accompanying Safety Data Sheet (SDS), in line with the Globally Harmonized System (GHS) for Classification and Labeling of Chemicals, electronically submitted to the Authority's Safety Division via email attention to: sds@gpagwa.com prior to its delivery _____
- B.2 - A hard copy of awarded SDS is required to accompany all chemicals upon official delivery onto the Authority property. _____

C. LOSS EVALUATION:

- C.1 - Bid award for pad mounted transformers shall be based on the Total Cost of Ownership (TCO) and all other requirements as specified in GPA Specification E-004, Revision 10, Section 6. _____

D. MARKING REQUIREMENTS:

- D.1 - Stencil 1" GPA Index No./ Purchase Order No./ Bid No./ Serial No. and Date of MFG. (DO NOT OBLITERATE MFG LABEL) _____
- D.2 - Manufacturer Serial No. shall be shown on all delivery receipts and invoices. _____
- D.3 - All transformers shall have a weather resistant decal certifying NON-PCB. _____
- D.4 - Vendors are to provide a user's manual and certified laboratory test report for every transformer delivered. _____
- D.5 - Vendors are responsible to de-van materials from containers. _____
- D.6 - Vendors are responsible to provide a means to off load transformers that are 750 kVA or larger. _____
- D.7 - Transformers shall meet all U.S. Department of Energy requirements. _____
- D.8 - Transformer shall be placed and crated with suitable materials to prevent damage and injury during shipment and handling operations. _____

E. SUBMITTALS:

- E.1 - The bidder shall provide with the following data with their bid submittal:
 - a. Nameplate Data _____
 - b. Connection Diagrams _____
 - c. Guaranteed full load loss at 100% voltage and load _____
 - d. Guaranteed no-load loss at rated voltage _____
 - e. Shop Drawings _____

f. Completed Appendix A – Pad Mounted Transformer Information Sheet

E.2 - Information for initial bid review shop drawings shall include:

- a. Mounting dimensions
- b. Location of equipment, devices and terminals
- c. Estimated Weight
- d. Estimated number of gallons of oil
- e. Sample Nameplate Data
- f. Connection diagrams
- g. Guaranteed Full load loss at 100% voltage and load
- h. Guaranteed No-Load Loss at Rated Voltage

E.3 – The transformer shall withstand the following environmental tests for 2000 hours:

- a. ASTM B117, Standard Method of Salt Spray (Fog) Testing.

E.4 – Vendor shall comply with GPA E-004, Revision 10 Page 20 of 20 Appendix A Pad Mounted Transformer Information Sheet.

- a. Kindly complete the product information and provided the required documents. Incomplete information shall be cause for rejection.

****APPROVED EQUAL TO OR BETTER****

All deviations shall be identified referencing the Section and Sub-Section(s) from the attached GPA Specification.

NOTE:

Bidders must state either “Comply” or “Not Comply” against each specification on the bid document.

NOTE:

Not withstanding the fact that this contract was written by one (1) party, it will be construed that is was written by two (2) parties.

REMARKS / DEVIATIONS:

DELIVERY REQUIREMENT:

24 Weeks After Approved Drawings by Guam Power Authority

Reasonable delivery extension requests for this specific bid will be duly considered with the supporting manufacturer documentation however, such request are not guaranteed approval due to critical and urgent need of the materials to support the Guam Power Authority's needs.

Specifications Generated/Reviewed by:

Angela Balajadia 04/28/2026
 ANGELA BALAJADIA Date
 Inventory Management Officer

TO BE COMPLETED BY BIDDER:

MANUFACTURER/BRAND NAME: _____

CAT. NO. / MODEL NO.: _____

PLACE OF ORIGIN: _____

EXPORT ABROAD: _____

TIME OF DELIVERY AFTER APPROVED DRAWINGS BY GUAM POWER AUTHORITY: _____

Specifications Reviewed by:

Louis C. Camacho P.E. 4/27/2026
 LOUIS C. CAMACHO, P.E. Date
 Engineering Supervisor

Specifications Approved by:

Beatrice P. Limtiaco 4/28/2026
 BEATRICE P. LIMTIACO Date
 Assistant General Manager of Administration

 GUAM POWER AUTHORITY	SPECIFICATION No. E-004	Page 1 of 20
		July 29, 2022
PREPARED BY THE ENGINEERING DEPARTMENT		REV. 10

**GUAM POWER AUTHORITY
 P.O. BOX 2977
 HAGATNA, GUAM 96932**

TRANSMISSION & DISTRIBUTION SPECIFICATION

Specification No. E-004

FOR

THREE PHASE PAD MOUNTED DISTRIBUTION TRANSFORMER

EFFECTIVE DATE: 7-29-22	ISSUED: 	APPROVED: 
-------------------------	--	---

 GUAM POWER AUTHORITY	SPECIFICATION No. E-004	Page 2 of 20
		July 29, 2022
PREPARED BY THE ENGINEERING DEPARTMENT		REV. 10

THREE PHASE PAD MOUNTED DISTRIBUTION TRANSFORMER

TABLE OF CONTENTS

SECTION	PAGE
1.0 SCOPE.....	3
2.0 APPLICABLE PUBLICATIONS.....	3
3.0 DEVIATIONS AND NON-CONFORMANCE REQUIREMENTS.....	4
4.0 SUBMITTALS	5
5.0 CERTIFIED LABORATORY TEST REPORTS.....	6
6.0 LOSS EVALUATION.....	6
7.0 RATINGS.....	7
8.0 DESIGN	8
9.0 CONSTRUCTION.....	11
10.0 QUALITY CONTROL	18
11.0 PACKING AND SHIPPING	19
12.0 APPENDIX A	20

EFFECTIVE DATE: 7-29-22	ISSUED: 	APPROVED: 
-------------------------	--	---

 GUAM POWER AUTHORITY	SPECIFICATION No. E-004	Page 3 of 20
		July 29, 2022
PREPARED BY THE ENGINEERING DEPARTMENT		REV. 10

1.0 SCOPE

- 1.1 This specification covers GPA requirements for three-phase, dead-front, 60 Hz, mineral oil filled, 65° C rise pad mounted type distribution transformers for use with separable insulated high-voltage connectors.
- 1.2 The transformer is intended for use in tropical weather conditions with a corrosive sea air atmosphere, sustained wind strengths of 155 MPH with gusts to 180 MPH and subject to moderate and severe earthquakes.

2.0 APPLICABLE PUBLICATIONS

The transformers shall meet the requirements of the following standards, including the latest revisions with respect to material, design and tests.

- 2.1 AMERICAN NATIONAL STANDARDS INSTITUTE, INC. (ANSI)
 - C57** Requirements for Distribution Transformers
 - C68.1** Techniques for Dielectric Tests
 - C76** Apparatus Bushings
- 2.2 NATIONAL ELECTRICAL MANUFACTURERS ASSOCIATION (NEMA) STANDARDS
 - TR 1** Transformers, Regulators and Reactors
- 2.3 AMERICAN SOCIETY FOR TESTING AND MATERIALS (ASTM) STANDARDS
 - D3487** Mineral Insulating Oil used in Electrical Apparatus
 - D92** Manual Cleveland Flashpoint Tester
 - D877** Dielectric Breakdown Voltage of Insulating Liquids
- 2.4 NATIONAL FIRE PROTECTION ASSOCIATION (NFPA)
 - 70** National Electrical Code
 - 70B** Electrical Equipment Maintenance
- 2.5 FEDERAL SPECIFICATIONS
 - TT-P-636D** Red or Brown Iron-Oxide Primer for Galvanized Metal Surfaces

EFFECTIVE DATE: 7-29-22	ISSUED: 	APPROVED: 
-------------------------	--	---

 GUAM POWER AUTHORITY	SPECIFICATION No. E-004	Page 4 of 20
		July 29, 2022
PREPARED BY THE ENGINEERING DEPARTMENT		REV. 10

2.6 WESTERN UNDERGROUND COMMITTEE GUIDE 2.13

3.0 DEVIATIONS AND NON-CONFORMANCE REQUIREMENTS

- 3.1 Deviations from this specification or changes in the material or design after the purchase order has been placed must be approved by the GPA Engineering Department and acknowledged by a Purchase Order Amendment issued by GPA.
- 3.2 Units received with deviations or non-conformances that are not acknowledged per Section 3.1 are subject to rejection. The Supplier of rejected units is responsible for any corrective action including but not limited to materials, labor and transportation necessary to dispose of or make the units conform to the specification.
- 3.3 Notification of defective units discovered before or after installation that are believed to be inherent to manufacturing problems or workmanship shall be made and forwarded to the Supplier. The description of the item, documentation of the problem and the described information, disposition and/or follow-up (as appropriate) that GPA expects from the Supplier will be specified. The Supplier's response shall be made within thirty (30) days unless an extension is acknowledged and approved in writing by the GPA Manager of Engineering.
- 3.4 Warranty -- the Supplier shall warrant the distribution transformer to be free from defects in material and workmanship under normal use and service conditions. The term of the Warranty shall be the lesser of twelve (12) months from the date of initial installation or eighteen (18) months from date of receipt.
- 3.5 Statement of Compliance - The Supplier shall provide a signed statement verifying that the products being supplied fully comply with the specifications and drawings. Items not in full compliance with the specification and drawings will be identified with a description of the deficiency and any proposed substitutions. Items not in full compliance with the specifications and drawings must be approved by the GPA Engineering Department, as described in Section 3.1.

EFFECTIVE DATE: 7-29-22	ISSUED: 	APPROVED: 
-------------------------	--	---

 <p>GUAM POWER AUTHORITY</p>	<p>SPECIFICATION No. E-004</p>	Page 5 of 20
		July 29, 2022
<p>PREPARED BY THE ENGINEERING DEPARTMENT</p>		REV. 10

4.0 SUBMITTALS

4.1 The bidder shall provide the following data with their bid submittal:

- a. Nameplate Data
- b. Connection Diagrams
- c. Guaranteed full load loss at 100% voltage and load
- d. Guaranteed no-load loss at rated voltage
- e. Shop Drawings
- f. Completed Appendix A - **PAD-MOUNTED TRANSFORMER INFORMATION SHEET**

4.2 Information for initial bid review shop drawings shall include:

- a. Mounting dimensions
- b. Location of equipment, devices and terminals
- c. Estimated Weight
- d. Estimated Number of gallons of oil
- e. Sample Nameplate Data
- f. Connection diagrams
- g. Guaranteed full loss at 100% voltage and load
- h. Guaranteed no-load loss at rated voltage

4.3 After award of contract, final shop drawings indicating full details of construction and the outline of all connectors shall be submitted to GPA Engineering for review and approval. Information for FINAL shop drawings shall include:

- a. Mounting dimensions
- b. Location of equipment, devices and terminals
- c. Actual Weight
- d. Actual Number of gallons of oil
- e. Nameplate Data
- f. Connection diagrams

4.4 GPA shall be allowed two (2) weeks to review and approve final shop drawings provided in Section 4.3.1 without affecting the shipping date. Delays in delivery due to drawings that are disapproved during this review period are the responsibility of the Supplier.

4.5 Drawings returned to the Supplier as approved shall be considered authorization to proceed with the work. The approval of GPA shall in no way abrogate the requirements of this specification.

EFFECTIVE DATE: 7-29-22

ISSUED: 

APPROVED: 

 GUAM POWER AUTHORITY	SPECIFICATION No. E-004	Page 6 of 20
		July 29, 2022
PREPARED BY THE ENGINEERING DEPARTMENT		REV. 10

5.0 CERTIFIED LABORATORY TEST REPORTS

- 5.1 Certified tests shall be conducted in accordance with ANSI C57 plus a standard production impulse test. Transformers shall have passed all required tests demonstrating compliance with the design requirements and industry standards.
- 5.2 The Supplier shall also conduct tests to determine transformer load and no-load losses. This test data shall be certified as true and correct by an independent testing firm and submitted to the Authority.
- 5.3 The Supplier shall furnish two (2) copies of the certified test reports of all tests covered by this specification to the GPA Manager of Engineering prior to shipment.

6.0 LOSS EVALUATION

- 6.1 Each bidder shall submit with his bid the guaranteed load and no-load losses on each transformer submitted. Guaranteed load losses shall be provided at 85° C and shall be stated at the nominal voltage tap positions.
- 6.2 Guaranteed losses will be evaluated by GPA to determine the equivalent cost for owning and operating each transformer. The value of the transformer no-load and load losses will be determined by GPA at the time of purchase to arrive at the projected Total Cost of Ownership (TCO) as follows:

$$TCO = IC + A \times (P_o + P_{co}) + B \times (P_k + P_{cs} - P_{co}) \text{ Where:}$$

- P_o = No Load Losses (NLL) in kW (Provided by Bidder)
- P_{co} = Power Consumption of Cooling Equipment at No Load Operation (Zero Power Consumption of Cooling Equipment, unless otherwise provided)
- P_k = Load Losses (LL) in kW (Provided by Bidder)
- P_{cs} = Power Consumption of Cooling Equipment at Rated Power Operation (Zero Power Consumption of Cooling Equipment, unless otherwise provided)
- IC = Initial Transformer Cost (Provided by Bidder)
- $A = t \times C_{n/2} \times (1 - (1/(1+i))^n) / i$
- $B = u \times t \times C_{n/2} \times (1 - (1/(1+i))^n) / i$
- $u = k^2$
- t = Operating Hours per Year (24 Hours/Day X 365 Days/Year = 8760 Hours)
- i = Discount Rate (5% Used By GPA for Money Certificates Issued)

EFFECTIVE DATE: 7-29-22	ISSUED: 	APPROVED: 
-------------------------	--	---

 GUAM POWER AUTHORITY	SPECIFICATION No. E-004	Page 7 of 20
		July 29, 2022
PREPARED BY THE ENGINEERING DEPARTMENT		REV. 10

n = Expected Lifetime of the Transformer in Years (**GPA Uses 25 Years**)

$c_{n/2}$ = Is the Cost of energy at the Mid-Life of the Transformer

Note: If Annual increase of energy price is assumed to be constant, $c_{n/2}$ can be calculated using C, j & n

$$c_{n/2} = (C + (CX(1+J)^n)) / 2$$

C = Is the Initial Cost of Energy (\$) (**Calculated From the weighted average energy rate from the Revenue Report with Fuel-Non Fuel Data Dec 2017) (\$0.1007)**)

j = Is the Annual Increase of Energy Price (%) (**Calculated from the Base Rate Increases from 1998 to 2018) (1.0935%)**)

k = Is the Average Loading of the Transformer During its Lifetime (**Calculated using data From the GPA Distribution Analysis 2010-2015) (20.05%)**)

6.3 A Band of Equivalence method will be used when evaluating the total cost for owning and operating each transformer. Transformers with a TOC that is within 5% of the transformer with the lowest TOC will be considered equivalent. The transformer with the lowest purchase price within this band shall be considered the lowest bid.

6.4 GPA will review actual, certified load and no-load losses for each transformer. In the event the actual losses exceed the guaranteed losses, the Supplier's contract will be reduced. The price reduction shall be the difference between the guaranteed losses and the actual losses at the rates indicated above. Load and no-load loss penalties will be assessed independently. Bonuses will not be awarded for actual losses which are less than guaranteed. Any transformer with no-load losses or load losses greater than the tolerances indicated in ANSI C57 shall be rejected by the Authority.

7.0 RATINGS

7.1 The primary voltage rating is 13,800 V line to line.

7.2 Secondary Voltage rating shall be either 208Y/120V or 480Y/277V as required.

7.3 The insulation class is 15 kV and the primary-voltage BIL is 95 kV.

7.4 The required transformer kVA ratings will be indicated on the purchase order. See Table 1 for GPA pad mounted transformer kVA ratings.

EFFECTIVE DATE: 7-29-22	ISSUED: 	APPROVED: 
-------------------------	--	---

 GUAM POWER AUTHORITY	SPECIFICATION No. E-004	Page 8 of 20
		July 29, 2022
PREPARED BY THE ENGINEERING DEPARTMENT		REV. 10

TABLE 1. Transformer kVA, Minimum Impedance, and Secondary Spade Hole Count by Voltage

208Y/120V			480Y/277V		
kVA	Minimum Impedance (%)	Secondary Spade Hole Count	kVA	Minimum Impedance (%)	Secondary Spade Hole Count
45	1.3	6-hole	45	1.3	6-hole
75	1.3	6-hole	75	1.3	6-hole
150	1.3	6-hole	150	1.3	6-hole
225	1.6	6-hole	225	1.3	6-hole
300	2.2	8-hole	300	1.3	8-hole
500	3.5	8-hole	500	2.2	8-hole
750	5.75	10-hole	750	5.75	8-hole
1000	5.75	10-hole	1000	5.75	8-hole
1500	5.75	10-hole	1500	5.75	10-hole
			2000	5.75	10-hole

7.5 The transformer impedance shall be as indicated in Table 1. ANSI tolerances may be applied to these values. The impedance value shall be provided on the nameplate.

7.6 The transformer shall meet the latest energy efficiency standards for liquid immersed distribution pad mounted transformers required by the United States Department of Energy.

7.7 The Average Winding Rise shall be 65°C

8.0 DESIGN

8.1 High Voltage Taps Changer

- a. Unless otherwise specified, taps shall be furnished on the high voltage winding. Tap ratios shall conform to ANSI C57 for all transformers, with two 2½ % taps above and below the rated voltage.
- b. Taps shall be full KVA rated and have short circuit capability noted in ANSI C57.

EFFECTIVE DATE: 7-29-22	ISSUED: 	APPROVED: 
-------------------------	--	---

 <p>GUAM POWER AUTHORITY</p>	<p>SPECIFICATION No. E-004</p>	<p>Page 9 of 20</p>
		<p>July 29, 2022</p>
<p>PREPARED BY THE ENGINEERING DEPARTMENT</p>		<p>REV. 10</p>

- c. The location of the tap changer switch shall be placed so that it is easily accessible and not directly below the primary bushing so it is not blocked by the primary wires.
- d. The selection of the tap desired shall be obtained through the operation of an externally operated switch.
 - 1. The tap changer switch shall be designed for de-energized operation.
 - 2. The tap changer switch assembly shall be snap action or the handle designed to permit checking that a switching operation has been completed.
 - 3. The tap changer switch assembly shall be designed to prevent accidental operation.
 - 4. Tap positions shall be clearly marked near the switch handle and on the transformer nameplate.
 - 5. A clearly legible yellow sign in accordance with 9.14.c shall be located adjacent to the handle which identifies it as the tap changer handle and includes a warning to not operate energized.
- e. The tap changer operating handle shall be located either in the low-voltage compartment, above the low-voltage bushings or hot stick operable at the high voltage compartment without interfering when primary or secondary cables are installed.

8.2 Protection

- a. Transformers shall be supplied with primary bayonet-type, oil-immersed fuses with isolation links.
- b. Fuse links shall be replaceable without requiring cutting or grinding of the transformer tank.
- c. Bayonet fuses with isolation links shall meet the following requirements:
 - 1. A yellow sign in accordance with 9.14.c reading "CAUTION READ BAYONET OPERATING INSTRUCTION BEFORE RE-FUSING"

EFFECTIVE DATE: 7-29-22	ISSUED: 	APPROVED: 
-------------------------	--	---

 GUAM POWER AUTHORITY	SPECIFICATION No. E-004	Page 10 of 20
		July 29, 2022
PREPARED BY THE ENGINEERING DEPARTMENT		REV. 10

shall be located adjacent to bayonet fuses.

2. A closed-end trough or catch basin shall be provided to prevent oil dripping on cables and terminations.
3. Free clearance shall be provided for hot stick operation of bayonet fuses.
4. Bayonet fuses with isolation links shall be sized in accordance with Table 2.

TABLE 2. Transformer Fusing
(Bayonet with Isolation Link)

KVA	Rating(Amps)
45	3
75	6
150	12
225	15
300	25
500	30
750	C14
1000	C14
1500	C17
2000	C17

- d. Provide an externally operated load break oil rotary (LBOR) switch for radial feed on the primary side. The switch shall have two positions, open and closed and shall be placed away from the primary bushing and not directly below so it is not blocked by the primary wires.
- e. All transformers covered by this specification shall have an automatic pressure relief valve installed above the hottest temperature oil level in the low voltage compartment, near the right hand most edge to the right of the top bushing to prevent oil dripping on cables and terminations and to prevent spraying.

EFFECTIVE DATE: 7-29-22	ISSUED: 	APPROVED: 
-------------------------	--	---

 <p>GUAM POWER AUTHORITY</p>	<p>SPECIFICATION No. E-004</p>	<p>Page 11 of 20</p>
		<p>July 29, 2022</p>
<p>PREPARED BY THE ENGINEERING DEPARTMENT</p>		<p>REV. 10</p>

9.0 CONSTRUCTION

- 9.1 The transformer shall consist of a welded transformer tank which shall be sealed with a welded cover. The enclosure, tank, doors and base of the transformer (the part that makes contact with the mounting surface) shall be made of Type 304L stainless steel.
- 9.2 The high and low voltage compartment including the door, door handles, hinges, base and other exterior parts and accessories shall be made of Type 304L stainless steel.
- 9.3 A 2 point lifting provision minimum shall be provided to allow for level lifting.
- 9.4 The manufacturer shall identify the type of steel and the thickness of the metal in inches or in gage size, in which case the gage name shall be specified.
- 9.5 No part of the transformer shall allow deformation or standing water. The top of the transformer shall be convex so water will run off the top.
- 9.6 The transformer shall have an oil level gauge, fill plug, drain valve, and self-actuating pressure relief device.
- 9.7 An indication shall be provided for signifying the correct oil level at 25° C if fill plug is not at this level.
- 9.8 The transformer shall be supplied with a high and low voltage compartment barrier. The compartment barrier shall be removable.
- 9.9 The compartment with separable insulated high voltage connectors shall be covered by a single door.
- 9.10 Bushings and Terminals
 - a. High voltage separable insulated connector bushings.
 - 1. 15 kV, 200A loadbreak bushing wells and inserts shall be provided. The Supplier shall provide approved load break bushing insert(s), Elastimold 1601A4 or approved equal.
 - 2. Bushings shall be bonded to tank having a maximum resistance

EFFECTIVE DATE: 7-29-22	ISSUED: 	APPROVED: 
-------------------------	--	---

 <p>GUAM POWER AUTHORITY</p> <p>PREPARED BY THE ENGINEERING DEPARTMENT</p>	<p>SPECIFICATION No. E-004</p>	<p>Page 12 of 20</p>
		<p>July 29, 2022</p>
		<p>REV. 10</p>

between high voltage bushing shielding and tank of 5000 ohms.

3. Weatherproof protective caps shall be installed to remain in position during shipping and storage and not deteriorate prior to installation of transformer.
4. Configuration of the high voltage bushing wells and parking stands shall be as shown in Figure 1.

FIGURE 1. Minimum High Voltage Compartment dimensions per ANSI C57.12.34-2004

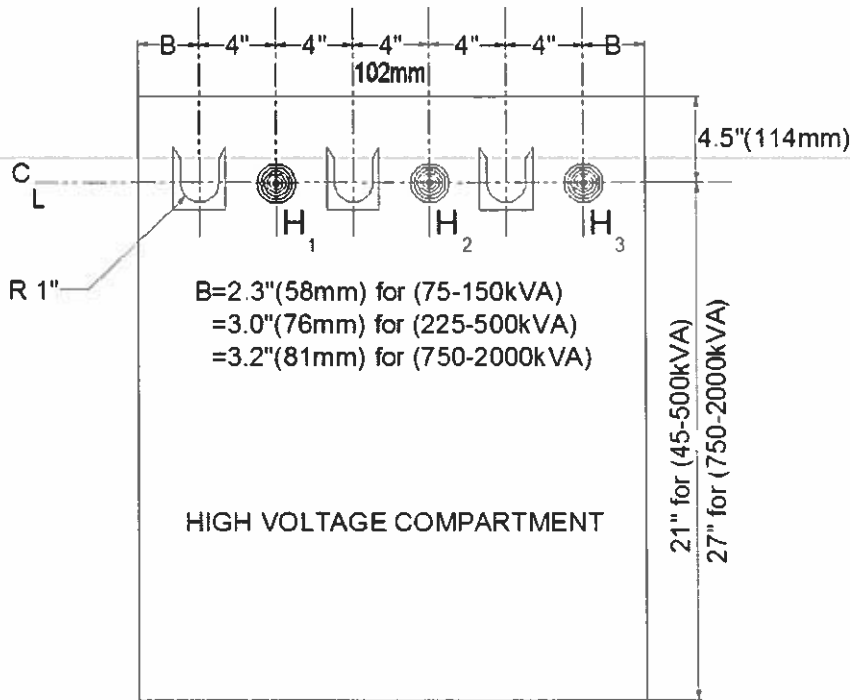

b. Low voltage terminals

1. Low voltage terminals hole counts shall be as designated in Table 1. Spade dimensions shall be as shown below in Figure 2.
 - a. Dimensions between centerline of holes shall be 1.75 inches plus or minus 0.03in (44.5mm plus or minus 0.8mm) both vertically and horizontally.
 - b. Thickness of spade shall be 0.25 inches (6mm) or greater as required to meet rated ampacities.
 - c. Hole diameters must be 0.56 inches(14.3mm) plus or

EFFECTIVE DATE: 7-29-22	ISSUED: 	APPROVED: 
-------------------------	--	---

 <p>GUAM POWER AUTHORITY</p>	<p>SPECIFICATION No. E-004</p>	<p>Page 13 of 20</p>
		<p>July 29, 2022</p>
<p>PREPARED BY THE ENGINEERING DEPARTMENT</p>		<p>REV. 10</p>

minus 0.03 inches(0.8mm).

FIGURE 2. Spade Dimensions

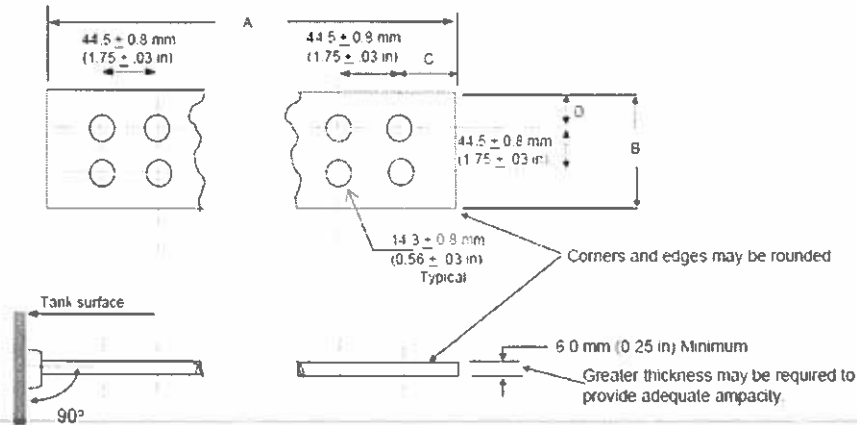

2. Low voltage terminals shall be plated for copper or aluminum cable terminations.
3. The low voltage neutral shall be fully insulated and **provided with a connected, removable neutral ground strap**, which shall be connected so as not to impair the bolted secondary connections.
4. Low voltage terminals shall be staggered as shown below in Figure 3 per ANSI C57.12.34-2004.

EFFECTIVE DATE: 7-29-22	ISSUED: 	APPROVED: 
-------------------------	--	---

 GUAM POWER AUTHORITY	SPECIFICATION No. E-004	Page 14 of 20
		July 29, 2022
PREPARED BY THE ENGINEERING DEPARTMENT		REV. 10

Figure 3 – Staggered Low Voltage terminal minimum dimensions per ANSI C57.12.34-2004 (45kVA added per GPA size requirements)



Tolerance	6mm(0.25")	6mm(0.25")
kVA Rating	E	D
45-150	127(5")	152mm(6")
225-2000	152mm(6")	203mm(8")

- c. The transformer shall have high and low voltage bushings which are externally clamped and replaceable without requiring access to the inside of the tank.
- d. Ground nuts/lugs for grounding connection to the grounding pads shall be provided with ground connector for #4 to 2/0 copper wires.
- e. Ground pads shall be provided on both the high and low voltage compartments. Ground pads shall conform to ANSI C57.12.34-2004 section 9.11. Where high and low voltage compartments are separated, these ground pads must be

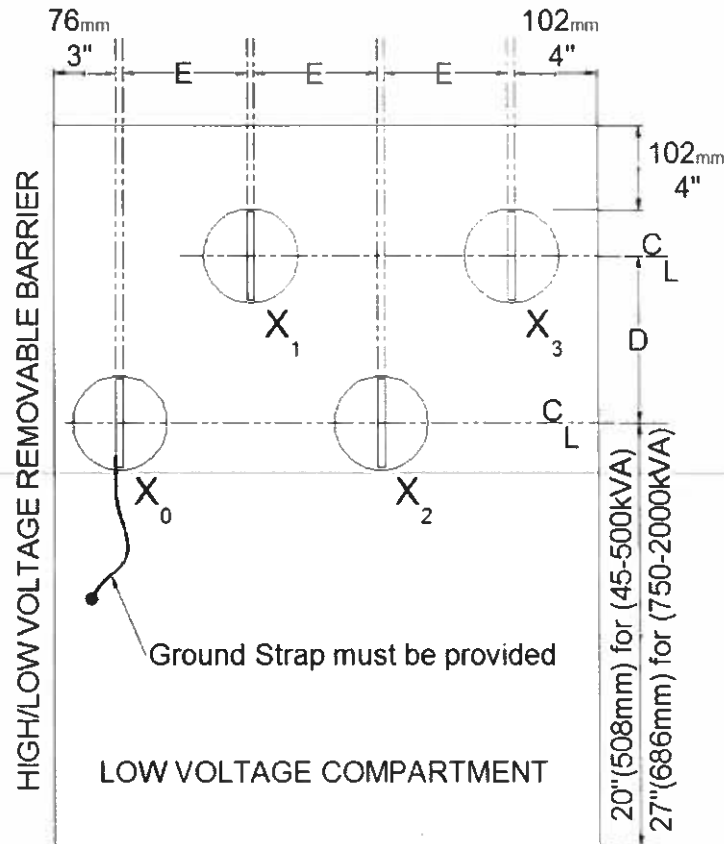
EFFECTIVE DATE: 7-29-22	ISSUED: 	APPROVED: 
-------------------------	--	---

 GUAM POWER AUTHORITY	SPECIFICATION No. E-004	Page 15 of 20
		July 29, 2022
PREPARED BY THE ENGINEERING DEPARTMENT		REV. 10

electrically bonded.

- f. Secondary bushing spade supports shall be furnished on all three phase transformers. Spade support method shall attach to the spade in an independent hole other than the cable connection holes. Spade support mounting shall be of insulating material with adjustable means to increase or decrease tension. Cross members of the spade supports shall be mounted off the cabinet wall and compartment separation barrier or to top of the transformer. Spade support components shall be designed to be easily removed and reassembled for assembly of cable to secondary spades. Supports must be attached to top of spades and not from the sides or the bottom which will impede the installation of cables.

9.11 Security Requirements

Access to the transformer compartment shall be secured by a minimum of two independent locking arrangements.

- a. The transformer locking design shall meet the requirements of the Western Underground Committee Guide 2.13, latest revision, "Security for Pad Mounted Equipment Enclosures."
- b. The transformer shall be designed to prevent wire entry and pass the following production quality control and receiving inspection test procedure:
 - 1. Any length of #12 AWG medium hard drawn solid bare copper wires shall be inserted into each opening until the wire enters the compartment or reaches an obstacle.
 - 2. If the wire reaches an obstacle, it can be bent and extended a maximum of three times at which time it shall be considered that the wire cannot be inserted into the enclosure.
 - 3. Entry of the wire into a compartment shall constitute a lack of tamper resistance and shall be cause for rejection. It is not necessary for the wire to actually contact energized components since entry into the compartment can establish potential contact conditions.
- c. Access into the transformer shall be secured by a recessed, captive, pentahead bolt which threads into a noncorrosive nut with a blind hole

EFFECTIVE DATE: 7-29-22	ISSUED: 	APPROVED: 
-------------------------	--	---

 GUAM POWER AUTHORITY	SPECIFICATION No. E-004	Page 16 of 20
		July 29, 2022
PREPARED BY THE ENGINEERING DEPARTMENT		REV. 10

to prevent the bolt from falling out of the door and a standard padlock.

- d. The padlocking device shall be so designed and located so as to resist prying or breaking off by screwdrivers, wrecking bars, tire irons, single-socket lug wrenches, or other readily accessible tools.
- e. Hinge pins shall be passivated AISI type 304 stainless steel or equivalent corrosion-resistant metal.
- f. The secondary compartment door shall be latched at a minimum of three points. In addition to the three-point latching, one pentahead bolt shall be coordinated with the latch and padlock to prevent unlatching and insertion of the padlock into the hasp until the bolt head is essentially completely seated, respectively.

Figure 4 – Three-point latching of Low Voltage Door

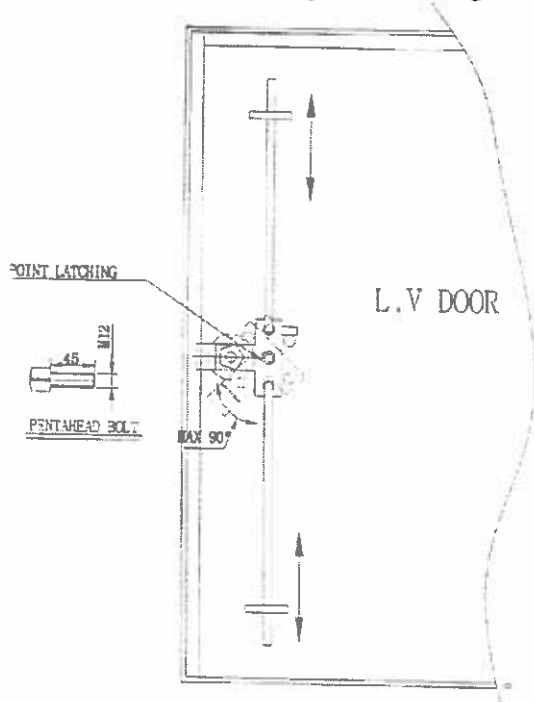

- g. Per ANSI C57.12.34-2004 section 9.3, the high-voltage door shall be secured separately from the low voltage door and entry into the high voltage door can only be done after opening the low-voltage door. The high-voltage door shall be secured with a bolt, preferably 5/8" to 11/16"

EFFECTIVE DATE: 7-29-22	ISSUED: 	APPROVED: 
-------------------------	--	---

 GUAM POWER AUTHORITY	SPECIFICATION No. E-004	Page 17 of 20
		July 29, 2022
PREPARED BY THE ENGINEERING DEPARTMENT		REV. 10

This is to allow work on the low voltage side of the transformer while the high voltage side is secured.

- h. The locking design shall be adequately sized for a standard padlock. The padlock shall not protrude beyond the front of the hood when installed. Hexagonal head bolts shall be Y2 inch and shall be of non-corrosive metal.
- i. The height of the padlock and pentahead provision shall be located near the center of the low voltage door and shall be no higher than 5 feet from the base of the transformer.

9.12 Finish Requirements

- a. The tank, compartment and all appurtenances shall be resistant to impact and corrosion under normal operating conditions in Guam's salt air environment.
 - 1. The total external dry-film thickness of the paint shall be 3.5 mils minimum or equivalent protection and 2.0 mils minimum on the interior compartment surfaces.
 - 2. All mating surfaces shall be designed to prevent degradation of corrosion protection, e.g. abrasion and impact. Mating surfaces at sill/hood junction shall be designed to prevent standing water corrosion.
 - 3. Surfaces in contact with, and a minimum of two inches above, the mounting surface shall be designed or treated to be resistant to corrosion and abrasion when unit is skidded and slid into place on the mounting pad.
- b. The transformer shall withstand the following environmental tests for 2000 hours:
 - 1. ASTM B117, Standard Method of Salt Spray (Fog) Testing.
 - 2. Ultraviolet Test, per ASTM D822, Standard Recommended Practice for Operating Light and Water Exposure Apparatus (Carbon-Arc type) for testing paint, varnish, lacquer and related products (ASTM G23 TypeD or better).

EFFECTIVE DATE: 7-29-22	ISSUED: 	APPROVED: 
-------------------------	--	---

 <p>GUAM POWER AUTHORITY</p>	<p>SPECIFICATION No. E-004</p>	<p>Page 18 of 20</p>
		<p>July 29, 2022</p>
<p>PREPARED BY THE ENGINEERING DEPARTMENT</p>		<p>REV. 10</p>

9.13 Transformer Identification and Labeling Requirements

- a. High voltage and low voltage terminal designations shall be located directly above their respective terminals.
- b. Transformer KVA rating, designated high voltage nameplate and designated low voltage nameplate shall be located inside the door and plainly visible with door open.
- c. Signs shall be yellow stenciled or approved decals. Decals shall have yellow printing on a black or clear background, or black printing on a yellow background, reverse printed on Scotch Cal material with pressure sensitive adhesive or an equivalent approved by GPA Engineering.
- d. Nameplate
 - 1. The nameplate shall be made of corrosion resistant material and shall comply with applicable industry standards for distribution transformers.
 - 2. The nameplate shall be permanent showing all of the required information, including KVA, voltage rating, ratio, BIL, weight, winding material, month and year of manufacture, impedance, high voltage and low voltage material, etc.
 - 3. The nameplate shall have rounded corners, and shall not be mounted more than 1/4" from the surface so as not to constitute a personnel hazard during bare hand secondary make up.

10.0 QUALITY CONTROL

- 10.1 The Supplier shall have a quality control program to ensure compliance with the requirements of this specification. The program shall be documented and available for GPA's review if requested.
- 10.2 Documentation of the quality control program shall indicate where in the production and manufacturing process the quality checks are taken, describe the purpose of the checks, and describe the nature of the check, e.g. if check is visual only or if electrical or mechanical testing is used.

EFFECTIVE DATE: 7-29-22	ISSUED: 	APPROVED: 
-------------------------	--	---

 GUAM POWER AUTHORITY	SPECIFICATION No. E-004	Page 19 of 20
		July 29, 2022
PREPARED BY THE ENGINEERING DEPARTMENT		REV. 10

11.0 PACKING AND SHIPPING

- 11.1 The supplier shall have adequate work and inspection instructions for handling, storage, preservation, packaging and shipping to protect the quality of the transformer and all attachments and to prevent damage, loss and deterioration of the transformer and its appurtenances.
- 11.2 The transformer shall be placed and crated with suitable material to prevent damage and injury during shipment and handling operations.
- 11.3 The transformer shall be securely blocked to prevent shifting during transit.

EFFECTIVE DATE: <i>7-29-22</i>	ISSUED: 	APPROVED: 
--------------------------------	--	---

 GUAM POWER AUTHORITY	SPECIFICATION No. E-004	Page 20 of 20
		July 29, 2022
PREPARED BY THE ENGINEERING DEPARTMENT		REV. 10

Appendix A

THREE PHASE PAD-MOUNTED TRANSFORMER INFORMATION SHEET

NOTE: Please complete the product information and provide the required documents. Incomplete information shall be cause for rejection.

Product Information			
1.	Transformer Phase		
2.	Primary Voltage 13800V Line to Line		
3.	Secondary Voltage	208Y/ 120V	480Y/ 277V
4.	Transformer kVA Size		
5.	Insulation Class Rating		
6.	Primary Voltage BIL Rating		
7.	Impedance		
8.	Bay-O-Net Fuse (Specify size)	Quantity :	Yes No
9.	Radial Feed		Yes No
10.	2 position Load Break Oil Rotary Switch		Yes No
11.	Pentahead, recessed and captive		Yes No
12.	Provision for padlock recessed to reduce tampering		Yes No
13.	Auto Pressure Relief Valve		Yes No
14.	Staggered Secondary Configuration		Yes No
15.	Drain Plug/Valve		Yes No
16.	Fill Plug		Yes No
17.	Tap Changer (2 taps 2.5% above and below rated)		Yes No
18.	Ground Strap provided		Yes No
19.	Ground provisions with Ground Connectors provided for #4 to #2/0cu (2 ea.)		Yes No
20.	Are all parts of the transformer such as hood, doors, hinges, tank, base and other parts and accessories made of Type 304L Stainless Steel?		Yes No
21.	Flip Top Hood		Yes No
22.	Is there a Convex Top		Yes No
23.	Lifting provisions provided		Yes No
24.	Secondary Spade Terminals provided. (Specify Hole Count)		Yes No
25.	Primary 200A Load break insert provided (Specify model number and manufacturer)		Yes No
26.	Guaranteed No Load Loss (Per Section 4.2)		
27.	Guaranteed Full Load Loss (Per Section 4.2)		

Required Documents		
1.	Sample Nameplate Data	Yes No
2.	Connection Diagrams	Yes No
3.	Shop Drawings	Yes No

EFFECTIVE DATE: 7-29-22	ISSUED: 	APPROVED: 
-------------------------	--	---



GUAM POWER AUTHORITY

ATURIDĀT ILEKTRESEDĀT GUĀHAN
P.O.BOX 2977 • HAGĀTÑA, GUAM U.S.A. 96932-2977

Telephone Nos. (671) 648-3045/55 Fax: 648-3165

Lourdes A. Leon Guerrero
I Maga 'håga

Joshua F. Tenorio
I Sigundo Maga 'låhi

BID BOND

NO.: _____

KNOW ALL MEN BY THESE PRESENTS that _____, as

Principal Hereinafter called the Principal, and (Bonding Company), _____
A duly admitted insurer under the laws of the Territory of Guam, as Surety, hereinafter called the Surety are
Held firmly bound unto the Territory of Guam for the sum of _____ Dollars
(\$ _____), for Payment of which sum will and truly to be made, the said Principal and the said
Surety bind ourselves, our heirs, executors, administrators, successors and assigns, jointly and severally, firmly
by these presents.

WHEREAS, the Principal has submitted a bid for (identify project by number and brief description)

NOW, THEREFORE, if the Territory of Guam shall accept the bid of the Principal and the Principal shall
enter into a Contract with the Territory of Guam in accordance with the terms of such bid, and give such bond or
bonds as my be specified in bidding or Contract documents with good and sufficient surety for the faithful
performance of such Contract Documents with good and sufficient surety for the faithful performance of such
Contract and for the prompt payment of labor and material furnished in the prosecution thereof, or in the event
of the failure of the Principal to enter such Contract and give such bond or bonds, if the Principal shall pay to the
Territory of Guam the difference not to exceed the penalty hereof between the amounts specified in said bid
and such larger amount for which the Territory of Guam may in good faith contract with another party to perform
work covered by said bid or an appropriate liquidated amount as specified in the Invitation for Bids then this
obligation shall be null and void, otherwise to remain full force and effect.

Signed and sealed this _____ day of _____ 2026.

(PRINCIPAL) (SEAL)

(WITNESS)

(TITLE)

(MAJOR OFFICER OF SURETY)

(TITLE)

(TITLE)

(RESIDENT GENERAL AGENT)

SEE INSTRUCTIONS FOR SUPPORTING DOCUMENTS REQUIRED.

INSTRUCTION TO PROVIDERS.

NOTICE to all Insurance and Bonding Institutions:

The Bond requires the signatures of the Vendor, two (2) major Officers of the Surety and Resident General Agent, if the Surety is a foreign or alien surety.

When the form is submitted to the Guam Power Authority, it should be accompanied with copies of the following:

1. Current Certificate of Authority to do business on Guam issued by the Department of Revenue and Taxation.
2. Power of Attorney issued by the Surety to the Resident General Agent or the following:
 - a. Current Sworn Annual Report (Limited Liability Company (LLC) and/or Corporation) or;
 - b. Current Renewal of Annual Limited Liability Partnership (LLP)

The following reference links below are for reference:

https://www.govguamdocs.com/revtax/docs/SwornAnnualReport_LLC_0609.pdf
https://www.govguamdocs.com/revtax/docs/SwornAnnualReport_Corporations.pdf
https://www.govguamdocs.com/revtax/docs/Renewal_LLP_Registration_r1106.pdf

3. Power of Attorney issued by two (2) major officers of the Surety to whoever is signing on their behalf.

Bonds, submitted as Bid Guarantee, without signatures and supporting documents are invalid and Bids will be rejected.



GUAM POWER AUTHORITY

ATURIDĀT ILEKTRESEDĀT GUĀHAN
P.O.BOX 2977 • HAGĀTÑA, GUAM U.S.A. 96932-2977

SPECIAL PROVISION FOR OWNERSHIP & INTEREST DISCLOSURE AFFIDAVIT

All Bidders/Offerors are required to submit a current affidavit as required below. Failure to do so will mean disqualification and rejection of the Bid/RFP.

5 GCA §5233 (Title 5, Section 5233) states: Disclosure of Ownership, Financial, and Conflicts of Interest

- (a) Purpose. The disclosure required by this Section are intended to reveal information bearing on the responsibility of a bidder, and can be obtained by an inquiry regarding responsibility prior to award.
- (b) Definitions.
As used herein, the term "person" shall be interpreted liberally to include the definition found in 1 GCA § 715, and in § 5030(n) of this Chapter, and includes a natural person as well as every entity of whatever form or composition (an "artificial person") recognized under the laws of Guam other than a natural person, who is a prospective contractor under a bid, offer, proposal, or other response to a solicitation, or is a contractor under a contract with the government of Guam, and subject to the provisions of this Chapter.
- (c) Public Disclosure of Ownership.
- (1) The ownership interests to be disclosed under this Section include the interests of a natural or artificial person who owns all or any part of a prospective contractor, bidder, or offeror, whether as proprietor, a partner, limited or otherwise, a shareholder of any class, in which case the percentage ownership interest test shall be based on each class, a member of an association or company, limited or otherwise, and any person owning a beneficial legal interest in any trust, and any other person having the power to control the performance of the contract or the prospective contractor.
 - (2) Prior to award, every person who is a prospective contractor, bidder, or offeror of a contract to be acquired under any method of source selection authorized by this Chapter shall submit a Disclosure Statement, executed as an affidavit under oath, disclosing the name of each person who currently or has owned an ownership interest in the prospective contractor, bidder, or offeror greater than ten percent (10%) at any time during the twelve (12) month period immediately preceding the date of the solicitation (the "relevant disclosure period").
 - (A) If a prospective contractor, bidder, or offeror is an artificial person, the Disclosure Statement shall disclose the name of each person who has owned an ownership interest in such artificial person (a "second tier owner") greater than twenty-five percent (25%) at any time during the relevant disclosure period.
 - (B) If any such second tier owner is also an artificial person, the Disclosure Statement shall disclose the name of each person who has owned an ownership interest in such second tier owner (a "third tier owner") of forty-nine percent (49%) or more during the relevant disclosure period.
 - (C) If the name of no natural person has been identified as an owner, or a second or third tier owner of the prospective contractor, bidder, or offeror, the Disclosure Statement shall identify the name, position, address, and contact information of the natural person having the authority and responsibility for the performance of the prospective contract, and the name of any natural person who has the authority and power to remove and replace the designated responsible person or otherwise control the performance of the prospective contract.
- (d) Disclosure of Financial Interest. A prospective contractor shall execute an affidavit disclosing the name of any person who has received or is entitled to receive a commission, gratuity, contingent fee or other compensation to solicit, secure, or assist in obtaining business related to the solicitation by means of a Disclosure Statement, executed as an affidavit under oath, disclosing such interest and shall also contain the amounts of any such commission, gratuity, contingent fee or other compensation.
- (e) Disclosure of Conflict of Interest. A prospective contractor shall disclose the name of any person who directly or indirectly participates in any solicitation if such person is also an employee of the government of Guam, or of the government of the United States if federal funds are used in payment of the contract.

- (f) Every disclosure of an ownership or financial interest of any person required to be identified by this Section shall name the person required to be disclosed and the street address of their principal place of business. All information disclosed or meant to be disclosed under this Section is public procurement data and shall be kept as part of the public record of each procurement.
- (g) Continuing Duty of Disclosure. Notwithstanding any other provision of this Chapter, the duty to disclose the information required under this Section shall be, upon award a continuing duty of a contractor of every contract subject to this Chapter, and all such information shall become part of the procurement record required by § 5249 of this Chapter. Throughout the term of a contract subject to the terms of this Chapter, the contractor shall promptly make any disclosures not made previously and update changes in the identities or other required information, interests, or conflicts of the persons required to be disclosed herein. Failure to comply with this Section shall constitute a material breach of contract."

Section 2. Severability. If any provision of this Act or its application to any person or circumstance is found to be invalid or contrary to law, such invalidity shall not affect other provisions or applications of this Act that can be given effect without the invalid provision or application, and to this end the provisions of this Act are severable.

1. If the affidavit is a copy, indicate the BID/RFP number and where it is filed.
2. Affidavits must be signed within 60 days of the date the bids or proposals are due.

OWNERSHIP & INTEREST DISCLOSURE AFFIDAVIT

TERRITORY OF GUAM)
)
HAGATNA, GUAM)

I, undersigned, _____, being first duly sworn, deposes and says:
(partner or officer of the company, etc.)

1. That the name of each person who owns or has owned an ownership interest in the prospective contractor, bidder, or offeror greater than ten (10%) at any time during the twelve (12) month period immediately preceding the date of this solicitation are as follows:

Table with 3 columns: Name, Street Address (Principal Place of Business), Percentage of Shares Held. Includes three rows of blank lines for data entry.

Total percentage of shares: _____

2. That for any owners listed Section 1 who are artificial persons, the name of each person who owns or has owned an interest in such artificial person (a "second-tier owner") greater than twenty-five percent (25%) at any time during the relevant disclosure period are as follows:

Table with 3 columns: Name, Street Address (Principal Place of Business), Percentage of Shares Held. Includes three rows of blank lines for data entry.

Total percentage of shares: _____

3. That for any owners listed Section 2 who are artificial persons, the name of each person who has owned an ownership interest in such second-tier owner (a "third-tier owner") of forty-nine percent (49%) or more during the relevant disclosure period are as follows:

Table with 3 columns: Name, Street Address (Principal Place of Business), Percentage of Shares Held. Includes three rows of blank lines for data entry.

Total percentage of shares: _____

4. That if no natural person has been identified as an owner in Section 1-3 above, the natural person having the authority and responsibility for the performance of the prospective contract:

Table with 3 columns: Name & Position, Street Address (Principal Place of Business), Contact Information. Includes two rows of blank lines for data entry.

The natural person having the authority and power to remove and replace the designated responsible person or otherwise control the performance of the prospective contract:

Table with 3 columns: Name & Position, Street Address (Principal Place of Business), Contact Information. Includes one row of blank lines for data entry.

5. Persons who have received or are entitled a commission, gratuity or other compensation for procuring or assisting in obtaining business related to the Bid/RFP for which this Affidavit is submitted are as follows:

Table with 3 columns: Name, Address, Amount of Commission, Gratuity, or other Compensation. Includes two rows of blank lines for data entry.

- 6. Persons who directly or indirectly participated in this solicitation, if government of Guam employees (or government of the United States employees, if federal funds are used in payment of the contract):

<u>Name & Position</u>	<u>Street Address (Principal Place of Business)</u>	<u>Contact Information</u>
_____	_____	_____
_____	_____	_____

Further, affiant sayeth naught.

Date: _____

 Signature of individual if bidder/offeror is a sole Proprietorship; Partner, if the bidder/offeror is a Partnership Officer, if the bidder/offeror is a corporation.

Subscribe and sworn to before me this _____ day of _____,

20_____.

Notary Public: _____

In and for the Territory of Guam

My Commission expires _____.

NON-COLLUSION AFFIDAVIT

Guam)
)ss:
Hagatna)

I, _____ first being duly sworn, depose and say:
(Name of Declarant)

1. That I am the _____ of _____.
(Title) (Name of Bidding/RFP Company)
2. That in making the foregoing proposal or bid, that such proposal or bid is genuine and not collusive or sham, that said bidder/offeror has not colluded, conspired, connived or agreed, directly or indirectly, with any bidder or person, to put in a sham or to refrain from bidding or submitting a proposal and has not in any manner, directly or indirectly, sought by agreement or collusion, or communication or conference, with any person, to fix the bid of affiant or any other bidder, or to secure any overhead, project or cost element of said bid price, or of that of any bidder, or to secure any advantage against the GUAM POWER AUTHORITY or any person interested in the proposed contract; and
3. That all statements in said proposal or bid are true.
4. This affidavit is made in compliance with Guam Administrative Rules and Regulations §§3126(b).

(Declarant)

SUBSCRIBED AND SWORN to me before this _____ day of _____, 2026.

)Seal(

Notary Public

NO GRATUITIES OR KICKBACKS AFFIDAVIT

AFFIDAVIT
(Offeror)

TERRITORY OF GUAM)
)
HAGATNA, GUAM) SS:

_____, being first duly sworn, deposes and says:

As the duly authorized representative of the Offeror, that neither I nor of the Offeror's officers, representatives, agents, subcontractors, or employees has or have offered, given or agreed to give any government of Guam employee or former employee, any payment, gift, kickback, gratuity or offer of employment in connection with Offeror's proposal.

Signature of Individual if Proposer is a Sole Proprietorship;
Partner, if the Proposer is a Partnership;
Officer, if the Proposer is a Corporation

SUBSCRIBED AND SWORN to before me this ____day of _____, 2026.

Notary Public
In and for the Territory of Guam
My Commission Expires:

DECLARATION RE-COMPLIANCE WITH U.S. DOL WAGE DETERMINATION

Procurement No.: _____

Name of Offeror Company: _____

_____ hereby certifies under penalty of perjury:

(1) That I am _____ (the offeror, a partner of the offeror, an officer of the offeror) making the bid or proposal in the foregoing identified procurement;

(2) That I have read and understand the provisions of 5 GCA § 5801 and § 5802 which read:

§ 5801. Wage Determination Established.

In such cases where the government of Guam enters into contractual arrangements with a sole proprietorship, a partnership or a corporation ('contractor') for the provision of a service to the government of Guam, and in such cases where the contractor employs a person(s) whose purpose, in whole or in part, is the direct delivery of service contracted by the government of Guam, then the contractor shall pay such employee(s) in accordance with the Wage Determination for Guam and the Northern Mariana Islands issued and promulgated by the U.S. Department of Labor for such labor as is employed in the direct delivery of contract deliverables to the government of Guam.

The Wage Determination most recently issued by the U.S. Department of Labor at the time a contract is awarded to a contractor by the government of Guam shall be used to determine wages, which shall be paid to employees pursuant to this Article. Should any contract contain a renewal clause, then at the time of renewal adjustments, there shall be made stipulations contained in that contract for applying the Wage Determination, as required by this Article, so that the Wage Determination promulgated by the U.S. Department of Labor on a date most recent to the renewal date shall apply.

§ 5802. Benefits.

In addition to the Wage Determination detailed in this Article, any contract to which this Article applies shall also contain provisions mandating health and similar benefits for employees covered by this Article, such benefits having a minimum value as detailed in the Wage Determination issued and promulgated by the U.S. Department of Labor, and shall contain provisions guaranteeing a minimum of ten (10) paid holidays per annum per employee.

(3) That the offeror is in full compliance with 5 GCA § 5801 and § 5802, as may be applicable to the procurement referenced herein;

Signature of Individual if Proposer is a Sole Proprietorship;
Partner, if the Proposer is a Partnership;
Officer, if the Proposer is a Corporation

SUBSCRIBED AND SWORN to before me this ____ day of _____, 2026.

Notary Public
In and for the Territory of Guam
My Commission Expires:

"REGISTER OF WAGE DETERMINATIONS UNDER THE SERVICE CONTRACT ACT By direction of the Secretary of Labor		U.S. DEPARTMENT OF LABOR EMPLOYMENT STANDARDS ADMINISTRATION WAGE AND HOUR DIVISION WASHINGTON D.C. 20210
--	--	--

Daniel W. Simms Director		Wage Determination No.: 2015-5693 Revision No.: 26 Date Of Last Revision: 12/03/2025
-----------------------------	--	--

States: Guam, Northern Marianas, Wake Island

Area: Guam Statewide
 Northern Marianas Statewide
 Wake Island Statewide

Fringe Benefits Required Follow the Occupational Listing

OCCUPATION CODE - TITLE	FOOTNOTE	RATE
01000 - Administrative Support And Clerical Occupations		
01011 - Accounting Clerk I		14.85
01012 - Accounting Clerk II		16.67
01013 - Accounting Clerk III		18.64
01020 - Administrative Assistant		23.15
01035 - Court Reporter		18.86
01041 - Customer Service Representative I		14.06
01042 - Customer Service Representative II		15.39
01043 - Customer Service Representative III		17.22
01051 - Data Entry Operator I		13.28
01052 - Data Entry Operator II		14.49
01060 - Dispatcher, Motor Vehicle		18.86
01070 - Document Preparation Clerk		15.02
01090 - Duplicating Machine Operator		15.02
01111 - General Clerk I		12.37
01112 - General Clerk II		13.50
01113 - General Clerk III		15.15
01120 - Housing Referral Assistant		21.02
01141 - Messenger Courier		12.00
01191 - Order Clerk I		13.76
01192 - Order Clerk II		15.02
01261 - Personnel Assistant (Employment) I		16.86
01262 - Personnel Assistant (Employment) II		18.86
01263 - Personnel Assistant (Employment) III		21.02
01270 - Production Control Clerk		25.27
01290 - Rental Clerk		11.10
01300 - Scheduler, Maintenance		16.86
01311 - Secretary I		16.86
01312 - Secretary II		18.86
01313 - Secretary III		21.02
01320 - Service Order Dispatcher		16.86
01410 - Supply Technician		23.15
01420 - Survey Worker		18.69
01460 - Switchboard Operator/Receptionist		10.98
01531 - Travel Clerk I		15.02
01532 - Travel Clerk II		16.85
01533 - Travel Clerk III		18.26
01611 - Word Processor I		15.02
01612 - Word Processor II		16.86
01613 - Word Processor III		18.86
05000 - Automotive Service Occupations		

05005 - Automobile Body Repairer, Fiberglass	19.14
05010 - Automotive Electrician	17.97
05040 - Automotive Glass Installer	16.81
05070 - Automotive Worker	16.81
05110 - Mobile Equipment Servicer	14.42
05130 - Motor Equipment Metal Mechanic	19.14
05160 - Motor Equipment Metal Worker	16.81
05190 - Motor Vehicle Mechanic	19.14
05220 - Motor Vehicle Mechanic Helper	13.20
05250 - Motor Vehicle Upholstery Worker	15.64
05280 - Motor Vehicle Wrecker	16.81
05310 - Painter, Automotive	17.97
05340 - Radiator Repair Specialist	16.81
05370 - Tire Repairer	12.98
05400 - Transmission Repair Specialist	19.14
07000 - Food Preparation And Service Occupations	
07010 - Baker	13.43
07041 - Cook I	16.18
07042 - Cook II	18.86
07070 - Dishwasher	10.00
07130 - Food Service Worker	10.57
07210 - Meat Cutter	13.36
07260 - Waiter/Waitress	9.89
09000 - Furniture Maintenance And Repair Occupations	
09010 - Electrostatic Spray Painter	19.70
09040 - Furniture Handler	11.94
09080 - Furniture Refinisher	19.70
09090 - Furniture Refinisher Helper	14.47
09110 - Furniture Repairer, Minor	17.15
09130 - Upholsterer	19.70
11000 - General Services And Support Occupations	
11030 - Cleaner, Vehicles	10.49
11060 - Elevator Operator	10.67
11090 - Gardener	16.81
11122 - Housekeeping Aide	10.67
11150 - Janitor	10.67
11210 - Laborer, Grounds Maintenance	12.71
11240 - Maid or Houseman	10.59
11260 - Pruner	11.37
11270 - Tractor Operator	15.39
11330 - Trail Maintenance Worker	12.71
11360 - Window Cleaner	11.92
12000 - Health Occupations	
12010 - Ambulance Driver	20.86
12011 - Breath Alcohol Technician	20.86
12012 - Certified Occupational Therapist Assistant	28.62
12015 - Certified Physical Therapist Assistant	28.62
12020 - Dental Assistant	18.79
12025 - Dental Hygienist	39.73
12030 - EKG Technician	31.60
12035 - Electroneurodiagnostic Technologist	31.60
12040 - Emergency Medical Technician	20.86
12071 - Licensed Practical Nurse I	18.65
12072 - Licensed Practical Nurse II	20.86
12073 - Licensed Practical Nurse III	23.25
12100 - Medical Assistant	14.50
12130 - Medical Laboratory Technician	18.93
12160 - Medical Record Clerk	14.97
12190 - Medical Record Technician	17.77
12195 - Medical Transcriptionist	18.65
12210 - Nuclear Medicine Technologist	45.85
12221 - Nursing Assistant I	12.91
12222 - Nursing Assistant II	14.52
12223 - Nursing Assistant III	15.85
12224 - Nursing Assistant IV	17.79

12235 - Optical Dispenser	20.86
12236 - Optical Technician	18.65
12250 - Pharmacy Technician	15.49
12280 - Phlebotomist	18.65
12305 - Radiologic Technologist	31.60
12311 - Registered Nurse I	25.85
12312 - Registered Nurse II	31.60
12313 - Registered Nurse II, Specialist	31.60
12314 - Registered Nurse III	38.24
12315 - Registered Nurse III, Anesthetist	38.24
12316 - Registered Nurse IV	45.85
12317 - Scheduler (Drug and Alcohol Testing)	25.85
12320 - Substance Abuse Treatment Counselor	25.85
13000 - Information And Arts Occupations	
13011 - Exhibits Specialist I	21.42
13012 - Exhibits Specialist II	26.53
13013 - Exhibits Specialist III	32.45
13041 - Illustrator I	21.42
13042 - Illustrator II	26.53
13043 - Illustrator III	32.45
13047 - Librarian	29.38
13050 - Library Aide/Clerk	17.05
13054 - Library Information Technology Systems Administrator	26.53
13058 - Library Technician	18.11
13061 - Media Specialist I	19.15
13062 - Media Specialist II	21.42
13063 - Media Specialist III	23.87
13071 - Photographer I	19.15
13072 - Photographer II	21.42
13073 - Photographer III	26.53
13074 - Photographer IV	32.45
13075 - Photographer V	39.27
13090 - Technical Order Library Clerk	21.42
13110 - Video Teleconference Technician	19.15
14000 - Information Technology Occupations	
14041 - Computer Operator I	15.71
14042 - Computer Operator II	17.22
14043 - Computer Operator III	19.19
14044 - Computer Operator IV	21.33
14045 - Computer Operator V	23.62
14071 - Computer Programmer I	(see 1) 15.73
14072 - Computer Programmer II	(see 1) 19.50
14073 - Computer Programmer III	(see 1) 23.84
14074 - Computer Programmer IV	(see 1)
14101 - Computer Systems Analyst I	(see 1) 24.23
14102 - Computer Systems Analyst II	(see 1)
14103 - Computer Systems Analyst III	(see 1)
14150 - Peripheral Equipment Operator	15.71
14160 - Personal Computer Support Technician	21.33
14170 - System Support Specialist	21.24
15000 - Instructional Occupations	
15010 - Aircrew Training Devices Instructor (Non-Rated)	24.23
15020 - Aircrew Training Devices Instructor (Rated)	29.32
15030 - Air Crew Training Devices Instructor (Pilot)	34.91
15050 - Computer Based Training Specialist / Instructor	24.23
15060 - Educational Technologist	31.17
15070 - Flight Instructor (Pilot)	34.91
15080 - Graphic Artist	20.47
15085 - Maintenance Test Pilot, Fixed, Jet/Prop	34.91
15086 - Maintenance Test Pilot, Rotary Wing	34.91
15088 - Non-Maintenance Test/Co-Pilot	34.91
15090 - Technical Instructor	17.67
15095 - Technical Instructor/Course Developer	23.78
15110 - Test Proctor	15.70

15120 - Tutor	15.70
16000 - Laundry, Dry-Cleaning, Pressing And Related Occupations	
16010 - Assembler	11.60
16030 - Counter Attendant	11.60
16040 - Dry Cleaner	13.23
16070 - Finisher, Flatwork, Machine	11.60
16090 - Presser, Hand	11.60
16110 - Presser, Machine, Drycleaning	11.60
16130 - Presser, Machine, Shirts	11.60
16160 - Presser, Machine, Wearing Apparel, Laundry	11.60
16190 - Sewing Machine Operator	13.79
16220 - Tailor	14.34
16250 - Washer, Machine	12.14
19000 - Machine Tool Operation And Repair Occupations	
19010 - Machine-Tool Operator (Tool Room)	19.70
19040 - Tool And Die Maker	24.77
21000 - Materials Handling And Packing Occupations	
21020 - Forklift Operator	15.87
21030 - Material Coordinator	25.27
21040 - Material Expediter	25.27
21050 - Material Handling Laborer	13.83
21071 - Order Filler	10.67
21080 - Production Line Worker (Food Processing)	15.87
21110 - Shipping Packer	17.12
21130 - Shipping/Receiving Clerk	17.12
21140 - Store Worker I	17.46
21150 - Stock Clerk	24.56
21210 - Tools And Parts Attendant	15.87
21410 - Warehouse Specialist	15.87
23000 - Mechanics And Maintenance And Repair Occupations	
23010 - Aerospace Structural Welder	25.04
23019 - Aircraft Logs and Records Technician	19.47
23021 - Aircraft Mechanic I	23.84
23022 - Aircraft Mechanic II	25.04
23023 - Aircraft Mechanic III	26.30
23040 - Aircraft Mechanic Helper	16.58
23050 - Aircraft, Painter	22.39
23060 - Aircraft Servicer	19.47
23070 - Aircraft Survival Flight Equipment Technician	22.39
23080 - Aircraft Worker	21.03
23091 - Aircrew Life Support Equipment (ALSE) Mechanic I	21.03
23092 - Aircrew Life Support Equipment (ALSE) Mechanic II	23.84
23110 - Appliance Mechanic	19.70
23120 - Bicycle Repairer	15.81
23125 - Cable Splicer	24.19
23130 - Carpenter, Maintenance	17.58
23140 - Carpet Layer	18.43
23160 - Electrician, Maintenance	20.04
23181 - Electronics Technician Maintenance I	18.43
23182 - Electronics Technician Maintenance II	19.70
23183 - Electronics Technician Maintenance III	20.98
23260 - Fabric Worker	17.15
23290 - Fire Alarm System Mechanic	17.12
23310 - Fire Extinguisher Repairer	15.81
23311 - Fuel Distribution System Mechanic	20.98
23312 - Fuel Distribution System Operator	15.81
23370 - General Maintenance Worker	14.03
23380 - Ground Support Equipment Mechanic	23.84
23381 - Ground Support Equipment Servicer	19.47
23382 - Ground Support Equipment Worker	21.03
23391 - Gunsmith I	15.81
23392 - Gunsmith II	18.43
23393 - Gunsmith III	20.98

23410 - Heating, Ventilation And Air-Conditioning Mechanic	20.22
23411 - Heating, Ventilation And Air Contidioning Mechanic (Research Facility)	21.51
23430 - Heavy Equipment Mechanic	20.66
23440 - Heavy Equipment Operator	18.87
23460 - Instrument Mechanic	20.98
23465 - Laboratory/Shelter Mechanic	19.70
23470 - Laborer	13.83
23510 - Locksmith	19.70
23530 - Machinery Maintenance Mechanic	26.47
23550 - Machinist, Maintenance	20.98
23580 - Maintenance Trades Helper	11.87
23591 - Metrology Technician I	20.98
23592 - Metrology Technician II	22.31
23593 - Metrology Technician III	23.62
23640 - Millwright	20.98
23710 - Office Appliance Repairer	19.46
23760 - Painter, Maintenance	18.74
23790 - Pipefitter, Maintenance	19.96
23810 - Plumber, Maintenance	18.75
23820 - Pneudraulic Systems Mechanic	20.98
23850 - Rigger	20.98
23870 - Scale Mechanic	18.43
23890 - Sheet-Metal Worker, Maintenance	20.80
23910 - Small Engine Mechanic	18.43
23931 - Telecommunications Mechanic I	20.98
23932 - Telecommunications Mechanic II	22.31
23950 - Telephone Lineman	22.68
23960 - Welder, Combination, Maintenance	19.96
23965 - Well Driller	21.13
23970 - Woodcraft Worker	20.98
23980 - Woodworker	15.81
24000 - Personal Needs Occupations	
24550 - Case Manager	16.09
24570 - Child Care Attendant	10.27
24580 - Child Care Center Clerk	13.25
24610 - Chore Aide	15.47
24620 - Family Readiness And Support Services Coordinator	16.09
24630 - Homemaker	16.12
25000 - Plant And System Operations Occupations	
25010 - Boiler Tender	22.79
25040 - Sewage Plant Operator	22.89
25070 - Stationary Engineer	22.79
25190 - Ventilation Equipment Tender	15.72
25210 - Water Treatment Plant Operator	22.89
27000 - Protective Service Occupations	
27004 - Alarm Monitor	11.89
27007 - Baggage Inspector	10.63
27008 - Corrections Officer	14.59
27010 - Court Security Officer	14.59
27030 - Detection Dog Handler	11.89
27040 - Detention Officer	14.59
27070 - Firefighter	14.59
27101 - Guard I	10.63
27102 - Guard II	11.89
27131 - Police Officer I	14.59
27132 - Police Officer II	16.21
28000 - Recreation Occupations	
28041 - Carnival Equipment Operator	13.68
28042 - Carnival Equipment Repairer	14.95
28043 - Carnival Worker	10.11
28210 - Gate Attendant/Gate Tender	14.50
28310 - Lifeguard	11.60

28350 - Park Attendant (Aide)	16.21
28510 - Recreation Aide/Health Facility Attendant	13.02
28515 - Recreation Specialist	20.09
28630 - Sports Official	12.91
28690 - Swimming Pool Operator	17.71
29000 - Stevedoring/Longshoremen Occupational Services	
29010 - Blocker And Bracer	28.62
29020 - Hatch Tender	28.62
29030 - Line Handler	28.62
29041 - Stevedore I	26.63
29042 - Stevedore II	30.60
30000 - Technical Occupations	
30010 - Air Traffic Control Specialist, Center (HFO) (see 2)	46.07
30011 - Air Traffic Control Specialist, Station (HFO) (see 2)	31.77
30012 - Air Traffic Control Specialist, Terminal (HFO) (see 2)	34.99
30021 - Archeological Technician I	18.41
30022 - Archeological Technician II	20.59
30023 - Archeological Technician III	25.51
30030 - Cartographic Technician	25.51
30040 - Civil Engineering Technician	25.51
30051 - Cryogenic Technician I	28.25
30052 - Cryogenic Technician II	31.21
30061 - Drafter/CAD Operator I	18.41
30062 - Drafter/CAD Operator II	20.59
30063 - Drafter/CAD Operator III	22.96
30064 - Drafter/CAD Operator IV	28.25
30081 - Engineering Technician I	17.32
30082 - Engineering Technician II	19.44
30083 - Engineering Technician III	21.74
30084 - Engineering Technician IV	26.94
30085 - Engineering Technician V	32.95
30086 - Engineering Technician VI	39.86
30090 - Environmental Technician	25.51
30095 - Evidence Control Specialist	25.51
30210 - Laboratory Technician	22.96
30221 - Latent Fingerprint Technician I	28.25
30222 - Latent Fingerprint Technician II	31.21
30240 - Mathematical Technician	25.51
30361 - Paralegal/Legal Assistant I	21.15
30362 - Paralegal/Legal Assistant II	26.20
30363 - Paralegal/Legal Assistant III	32.04
30364 - Paralegal/Legal Assistant IV	38.76
30375 - Petroleum Supply Specialist	31.21
30390 - Photo-Optics Technician	25.51
30395 - Radiation Control Technician	31.21
30461 - Technical Writer I	25.51
30462 - Technical Writer II	31.21
30463 - Technical Writer III	37.75
30491 - Unexploded Ordnance (UXO) Technician I	29.28
30492 - Unexploded Ordnance (UXO) Technician II	35.43
30493 - Unexploded Ordnance (UXO) Technician III	42.46
30494 - Unexploded (UXO) Safety Escort	29.28
30495 - Unexploded (UXO) Sweep Personnel	29.28
30501 - Weather Forecaster I	28.25
30502 - Weather Forecaster II	34.36
30620 - Weather Observer, Combined Upper Air Or Surface Programs	(see 2) 22.96
30621 - Weather Observer, Senior	(see 2) 25.51
31000 - Transportation/Mobile Equipment Operation Occupations	
31010 - Airplane Pilot	35.43
31020 - Bus Aide	8.97
31030 - Bus Driver	12.75
31043 - Driver Courier	10.53
31260 - Parking and Lot Attendant	9.91
31290 - Shuttle Bus Driver	12.48

31310 - Taxi Driver	11.41
31361 - Truckdriver, Light	11.50
31362 - Truckdriver, Medium	12.48
31363 - Truckdriver, Heavy	17.88
31364 - Truckdriver, Tractor-Trailer	17.88
99000 - Miscellaneous Occupations	
99020 - Cabin Safety Specialist	17.27
99030 - Cashier	10.51
99050 - Desk Clerk	10.13
99095 - Embalmer	29.28
99130 - Flight Follower	29.28
99251 - Laboratory Animal Caretaker I	26.81
99252 - Laboratory Animal Caretaker II	29.29
99260 - Marketing Analyst	21.54
99310 - Mortician	29.28
99410 - Pest Controller	16.07
99510 - Photofinishing Worker	15.39
99710 - Recycling Laborer	19.05
99711 - Recycling Specialist	25.72
99730 - Refuse Collector	18.04
99810 - Sales Clerk	11.36
99820 - School Crossing Guard	19.81
99830 - Survey Party Chief	24.38
99831 - Surveying Aide	13.87
99832 - Surveying Technician	18.02
99840 - Vending Machine Attendant	26.81
99841 - Vending Machine Repairer	34.14
99842 - Vending Machine Repairer Helper	26.81

ALL OCCUPATIONS LISTED ABOVE RECEIVE THE FOLLOWING BENEFITS:

HEALTH & WELFARE: \$5.55 per hour, up to 40 hours per week, or \$222.00 per week or \$962.00 per month

HEALTH & WELFARE EO 13706: \$5.09 per hour, up to 40 hours per week, or \$203.60 per week, or \$882.27 per month*

*This rate is to be used only when compensating employees for performance on an SCA-covered contract also covered by EO 13706, Establishing Paid Sick Leave for Federal Contractors. A contractor may not receive credit toward its SCA obligations for any paid sick leave provided pursuant to EO 13706.

VACATION: 2 weeks paid vacation after 1 year of service with a contractor or successor; and 4 weeks after 3 years. Length of service includes the whole span of continuous service with the present contractor or successor, wherever employed, and with the predecessor contractors in the performance of similar work at the same Federal facility. (Reg. 29 CFR 4.173)

HOLIDAYS: A minimum of eleven paid holidays per year: New Year's Day, Martin Luther King Jr.'s Birthday, Washington's Birthday, Memorial Day, Juneteenth National Independence Day, Independence Day, Labor Day, Columbus Day, Veterans' Day, Thanksgiving Day, and Christmas Day. (A contractor may substitute for any of the named holidays another day off with pay in accordance with a plan communicated to the employees involved.) (See 29 CFR 4.174)

THE OCCUPATIONS WHICH HAVE NUMBERED FOOTNOTES IN PARENTHESES RECEIVE THE FOLLOWING:

1) COMPUTER EMPLOYEES: This wage determination does not apply to any individual employed in a bona fide executive, administrative, or professional capacity, as defined in 29 C.F.R. Part 541. (See 41 C.F.R. 6701(3)). Because most Computer Systems Analysts and Computer Programmers who are paid at least \$27.63 per hour (or at least \$684 per week if paid on a salary or fee basis) likely qualify as exempt computer professionals under 29 U.S.C. 213(a)(1) and 29 U.S.C. 213(a)(17), this wage determination may not include wage rates for all occupations within those job families. In such instances, a conformance will be necessary if there are nonexempt employees in these job families working on the contract.

Job titles vary widely and change quickly in the computer industry, and are not determinative of whether an employee is an exempt computer professional. To be exempt, computer employees who satisfy the compensation requirements must also have a primary duty that consists of:

(1) The application of systems analysis techniques and procedures, including consulting with users, to determine hardware, software or system functional specifications;

(2) The design, development, documentation, analysis, creation, testing or modification of computer systems or programs, including prototypes, based on and related to user or system design specifications;

(3) The design, documentation, testing, creation or modification of computer programs related to machine operating systems; or

(4) A combination of the aforementioned duties, the performance of which requires the same level of skills. (29 C.F.R. 541.400).

Any computer employee who meets the applicable compensation requirements and the above duties test qualifies as an exempt computer professional under both section 13(a)(1) and section 13(a)(17) of the Fair Labor Standards Act. (Field Assistance Bulletin No. 2006-3 (Dec. 14, 2006)). Accordingly, this wage determination will not apply to any exempt computer employee regardless of which of these two exemptions is utilized.

2) AIR TRAFFIC CONTROLLERS AND WEATHER OBSERVERS - NIGHT PAY & SUNDAY PAY: If you work at night as part of a regular tour of duty, you will earn a night differential and receive an additional 10% of basic pay for any hours worked between 6pm and 6am. If you are a full-time employed (40 hours a week) and Sunday is part of your regularly scheduled workweek, you are paid at your rate of basic pay plus a Sunday premium of 25% of your basic rate for each hour of Sunday work which is not overtime (i.e. occasional work on Sunday outside the normal tour of duty is considered overtime work).

**** HAZARDOUS PAY DIFFERENTIAL ****

An 8 percent differential is applicable to employees employed in a position that represents a high degree of hazard when working with or in close proximity to ordnance, explosives, and incendiary materials. This includes work such as screening, blending, dying, mixing, and pressing of sensitive ordnance, explosives, and pyrotechnic compositions such as lead azide, black powder and photoflash powder.

All dry-house activities involving propellants or explosives. Demilitarization, modification, renovation, demolition, and maintenance operations on sensitive ordnance, explosives and incendiary materials. All operations involving re-grading and cleaning of artillery ranges.

A 4 percent differential is applicable to employees employed in a position that represents a low degree of hazard when working with, or in close proximity to ordnance, (or employees possibly adjacent to) explosives and incendiary materials which involves potential injury such as laceration of hands, face, or arms of the employee engaged in the operation, irritation of the skin, minor burns and the like; minimal damage to immediate or adjacent work area or equipment being used. All operations involving, unloading, storage, and hauling of ordnance, explosive, and

incendiary ordnance material other than small arms ammunition. These differentials are only applicable to work that has been specifically designated by the agency for ordnance, explosives, and incendiary material differential pay.

**** UNIFORM ALLOWANCE ****

If employees are required to wear uniforms in the performance of this contract (either by the terms of the Government contract, by the employer, by the state or local law, etc.), the cost of furnishing such uniforms and maintaining (by laundering or dry cleaning) such uniforms is an expense that may not be borne by an employee where such cost reduces the hourly rate below that required by the wage determination. The Department of Labor will accept payment in accordance with the following standards as compliance:

The contractor or subcontractor is required to furnish all employees with an adequate number of uniforms without cost or to reimburse employees for the actual cost of the uniforms. In addition, where uniform cleaning and maintenance is made the responsibility of the employee, all contractors and subcontractors subject to this wage determination shall (in the absence of a bona fide collective bargaining agreement providing for a different amount, or the furnishing of contrary affirmative proof as to the actual cost), reimburse all employees for such cleaning and maintenance at a rate of \$3.35 per week (or \$.67 cents per day). However, in those instances where the uniforms furnished are made of "wash and wear" materials, may be routinely washed and dried with other personal garments, and do not require any special treatment such as dry cleaning, daily washing, or commercial laundering in order to meet the cleanliness or appearance standards set by the terms of the Government contract, by the contractor, by law, or by the nature of the work, there is no requirement that employees be reimbursed for uniform maintenance costs.

**** SERVICE CONTRACT ACT DIRECTORY OF OCCUPATIONS ****

The duties of employees under job titles listed are those described in the "Service Contract Act Directory of Occupations", Fifth Edition (Revision 1), dated September 2015, unless otherwise indicated.

**** REQUEST FOR AUTHORIZATION OF ADDITIONAL CLASSIFICATION AND WAGE RATE, Standard Form 1444 (SF-1444) ****

Conformance Process:

The contracting officer shall require that any class of service employee which is not listed herein and which is to be employed under the contract (i.e., the work to be performed is not performed by any classification listed in the wage determination), be classified by the contractor so as to provide a reasonable relationship (i.e., appropriate level of skill comparison) between such unlisted classifications and the classifications listed in the wage determination (See 29 CFR 4.6(b)(2)(i)). Such conforming procedures shall be initiated by the contractor prior to the performance of contract work by such unlisted class(es) of employees (See 29 CFR 4.6(b)(2)(ii)). The Wage and Hour Division shall make a final determination of conformed classification, wage rate, and/or fringe benefits which shall be paid to all employees performing in the classification from the first day of work on which contract work is performed by them in the classification. Failure to pay such unlisted employees the compensation agreed upon by the interested parties and/or fully determined by the Wage and Hour Division retroactive to the date such class of employees commenced contract work shall be a violation of the Act and this contract. (See 29 CFR 4.6(b)(2)(v)). When multiple wage determinations are included in a contract, a separate SF-1444 should be prepared for each wage determination to which a class(es) is to be conformed.

The process for preparing a conformance request is as follows:

- 1) When preparing the bid, the contractor identifies the need for a conformed occupation(s) and computes a proposed rate(s).
- 2) After contract award, the contractor prepares a written report listing in order

the proposed classification title(s), a Federal grade equivalency (FGE) for each proposed classification(s), job description(s), and rationale for proposed wage rate(s), including information regarding the agreement or disagreement of the authorized representative of the employees involved, or where there is no authorized representative, the employees themselves. This report should be submitted to the contracting officer no later than 30 days after such unlisted class(es) of employees performs any contract work.

3) The contracting officer reviews the proposed action and promptly submits a report of the action, together with the agency's recommendations and pertinent information including the position of the contractor and the employees, to the U.S. Department of Labor, Wage and Hour Division, for review (See 29 CFR 4.6(b)(2)(ii)).

4) Within 30 days of receipt, the Wage and Hour Division approves, modifies, or disapproves the action via transmittal to the agency contracting officer, or notifies the contracting officer that additional time will be required to process the request.

5) The contracting officer transmits the Wage and Hour Division's decision to the contractor.

6) Each affected employee shall be furnished by the contractor with a written copy of such determination or it shall be posted as a part of the wage determination (See 29 CFR 4.6(b)(2)(iii)).

Information required by the Regulations must be submitted on SF-1444 or bond paper.

When preparing a conformance request, the ""Service Contract Act Directory of Occupations"" should be used to compare job definitions to ensure that duties requested are not performed by a classification already listed in the wage determination. Remember, it is not the job title, but the required tasks that determine whether a class is included in an established wage determination. Conformances may not be used to artificially split, combine, or subdivide classifications listed in the wage determination (See 29 CFR 4.152(c)(1))."

SPECIAL PROVISIONS

Restriction Against Sex Offenders Employed by Service Providers to Government of Guam from Working on Government of Guam Property

GCA 5 §5253 Restriction Against Contractors Employing Convicted Sex Offenders from Working at Government of Guam Venues:

- (a) No person convicted of a sex offense under the provisions of Chapter 25 of Title 9 Guam Code Annotated, or an offense as defined in Article 2 of Chapter 28, Title 9 GCA in Guam, or an offense in any jurisdiction which includes, at a minimum, all of the elements of said offenses, or who is listed on the Sex Offender Registry, and who is employed by a business contracted to perform services for an agency or instrumentality of the government of Guam, shall work for his employer on the property of the Government of Guam other than public highway.
- (b) All contracts for services to agencies listed herein shall include the following provisions: (1) warranties that no person providing services on behalf of the contractor has been convicted of a sex offense under the provisions of Chapter 25 of Title 9 GCA or an offense as defined in Article 2 of Chapter 28, Title 9 GCA, or an offense in another jurisdiction with, at a minimum, the same elements as such offenses, or who is listed on the Sex Offender Registry; and (2) that if any person providing services on behalf of the contractor is convicted of a sex offense under the provisions of Chapter 25 of Title 9 GCA or an offense as defined in Article 2 of Chapter 28, Title 9 GCA or an offense in another jurisdiction with, at a minimum, the same elements as such offenses, or who is listed on the Sex Offender Registry, that such person will be immediately removed from working at said agency and that the administrator of said agency be informed of such within twenty-four (24) hours of such conviction.
- (c) Duties of the General Services Agency or Procurement Administrators. All contracts, bids, or Requests for Proposals shall state all the conditions in § 5253(b).
- (d) Any contractor found in violation of § 5253(b), after notice from the contracting authority of such violation, shall, within twenty-four (24) hours, take corrective action and shall report such action to the contracting authority. Failure to take corrective action within the stipulated period may result in the temporary suspension of the contract at the discretion of the contracting authority.

SOURCE: *Added by P.L. 28-024:2 ((Apr. 21, 2005). Amended by P.L. 28-098:2 (Feb. 7, 2006).*

Signature of Bidder Date

Proposer, if an individual;
Partner, if a partnership;
Officer, if a corporation.

Subscribed and sworn before me this _____ day of _____, 2026.

Notary Public



GUAM POWER AUTHORITY

ATURIDĀT ILEKTRESEDĀT GUĀHAN
 P.O.BOX 2977 • HAGĀTÑA, GUAM U.S.A. 96932-2977

Lourdes A. Leon Guerrero
 I Maga 'håga

Telephone Nos. (671) 648-3045/55 Fax: 648-3165

Joshua F. Tenorio
 I Sigundo Maga 'låhi

Accountability	·	Impartiality	·	Competence	·	Openness	·	Value
----------------	---	--------------	---	------------	---	----------	---	-------

LOCAL PROCUREMENT PREFERENCE APPLICATION

Based on the law stipulated below, please place a checkmark or an "X" on the block indicating the item that applies to your business:

5GCA, Chapter 5, Section 5008, "Policy in Favor of Local Procurement" of the Guam Procurement Law states:

All procurement of supplies and services shall be made from among businesses licensed to do business on Guam and that maintains an office or other facility on Guam, whenever a business that is willing to be a contractor is:

- () (a) A licensed bonafide manufacturing business that adds at least twenty-five percent (25%) of the value of an item, not to include administrative overhead, suing workers who are U.S. Citizens or lawfully admitted permanent residents or nationals of the United States, or persons who are lawfully admitted to the United States to work, based on their former citizenship in the Trust Territory for the Pacific Islands; or
- () (b) A business that regularly carries an inventory for regular immediate sale of at least fifty percent (50%) of the items of supplies to be procured; or
- () (c) A business that has a bonafide retail or wholesale business location that regularly carries an inventory on Guam of a value of at least one half of the value of the bid or One Hundred Fifty Thousand Dollars (\$150,000.0) whichever is less, of supplies and items of a similar nature to those being sought; or
- () *(d) A service actually in business, doing a substantial business on Guam, and hiring at least 95% U.S. Citizens, lawfully admitted permanent residents or national of the United States, or persons who lawfully admitted to the United States to work, based on their citizenship in any of the nations previously comprising the Trust Territory of the Pacific Islands.

- Bidders indicating qualification under (d) may be considered QUALIFIED for the Local Procurement Preference **only if** the Government's requirement is for service. Service is defined Pursuant to 5 GCA Government Operations Subparagraph 5030 entitled DEFINITIONS under Chapter 5 of the Guam Procurement Law.

1. I _____, representative for _____, have read the requirements of the law cited above and do hereby qualify and elect to be given the LOCAL PROCUREMENT PREFERENCE for Bid No.: GPA _____. By filling in this information and placing my signature below, I understand that the Guam Power Authority will review this application and provide me with a determination whether or not the 15% preference will be applied to this bid.

2. I _____, representative for _____, have read the requirements of the law cited above, and do not wish to apply for the Local Procurement Preference for Bid No.: GPA _____.

 Bidder Representative Signature

 Date

NOTE:
 Prospective Bidders not completing this form will automatically be not considered for Local Procurement Preference. Non-completion of this form is not a basis for rejection of the bid or proposal.

GENERAL TERMS AND CONDITIONS**SEALED BID SOLICITATION AND AWARD****Only those Boxes checked below are applicable to this bid.**

1. **AUTHORITY:** This solicitation is issued subject to all the provision of the Guam Procurement Act (5GCA, Chapter 5) And the Guam Procurement Regulations (copies of both are available at the Office of the Complier of laws, Department of Law, copies available for inspection at the Guam Power Authority). It requires all parties involved in the Preparation, negotiation, performance, or administration of contracts to act in good faith.
2. **GENERAL INTENTION:** Unless otherwise specified, it is the declared and acknowledged intention and meaning of these General Terms and conditions for the bidder to provide the Government of Guam (Government) with specified services or with materials, supplies or equipment completely assembled and ready for use.
3. **TAXES:** Bidders are cautioned that they are subject to Guam Income Taxes as well as all other taxes on Guam Transactions. Specific information on taxes may be obtained from the Director of Revenue and Taxation.
4. **LICENSING:** Bidders are cautioned that the Government will not consider for award any offer submitted by a bidder who has not complied with the Guam Licensing Law. Specific information on licenses may be obtained from the Director of Revenue and Taxation.
5. **LOCAL PROCUREMENT PREFERENCE:** All procurement of supplies and services where possible, will be made from among businesses licensed to do business on Guam in accordance with section 5008 of the Guam Procurement Act (5GCA, Chapter 5) and Section 1-104 of the Guam Procurement Regulations.
6. **COMPLIANCE WITH SPECIFICATIONS AND OTHER SOLICITATION REQUIREMENTS:** Bidders shall comply with all specifications and other requirements of the Solicitation.
7. **“ALL OR NONE” BIDS:** Unless otherwise allowed under this Solicitation. “all or none” bids may be deemed to be non-responsive. If the bid is so limited, the Government may reject part of such proposal and award on the remainder.

NOTE: By checking this item, the Government is requesting all of the bid items to be bided or none at all. **The Government will not award on an itemized basis.** Reference: Section 3-101.06 of the Guam Procurement Regulations.

8. **INDEPENDENT PRICE DETERMINATION:** The bidder, upon signing the Invitation for Bid, certifies that the prices in his bid were derived at without collusion, and acknowledge that collusion and anti-competitive practices are prohibited by law. Violations will be subject to the provision of Section 5651 of that of the Guam Procurement Act. Other existing civil, criminal or administrative remedies are not impaired and may be in addition to the remedies in Section 5651 of the Government code.
9. **BIDDER'S PRICE:** The Government will consider not more than two (2) (Basic and Alternate) item prices and the bidder shall explain fully each price if supplies, materials, equipment, and/or specified services offered comply with specifications and the products origin. Where basic or alternate bid meets the minimum required specification, cost and other factors will be considered. Failure to explain this requirement will result in rejection of the bid.
10. **BID ENVELOPE:** Envelope shall be sealed and marked with the bidder's name, Bid number, time, date and place of Bid Opening.
11. **BID GUARANTEE REQUIREMENT:** Bidder is required to submit a Bid Guarantee Bond or standby irrevocable Letter of Credit or Certified Check or Cashier's Check in the same bid envelope to be held by the Government pending award. The Bid Guarantee Bond, Letter of Credit, Certified Check or Cashier's Check must be issued by any local surety or banking institution licensed to do business on Guam and made payable to the Guam Power Authority in the amount of fifteen percent (15%) of his highest total bid offer. The Bid Bond must be submitted on Government Standard Form BB-1 (copy enclosed). Personal Checks will not be accepted as Bid Guarantee. If a successful Bidder (contractor) withdraws from the bid or fails to enter into contract within the prescribed time, such Bid guarantee will be forfeited to the Government of Guam. Bids will be disqualified if not accompanied by Bid Bond, Letter of Credit, Certified Check or Cashier's check. Bidder must include in his/her bid, valid copies of a Power of Attorney from the Surety and a Certificate of Authority from the Government of Guam to show proof that the surety company named on the bond instrument is authorized by the Government of Guam and qualified to do business on Guam. For detailed information on bonding matters, contact the Department of Revenue and Taxation. Failure to submit a valid Power of Attorney and Certificate of Authority on the surety is cause for rejection of bid. (GPR Section 3-202.03.3) **Pursuant to Public Law 27-127, all competitive sealed bidding for the procurement of supplies or services exceeding \$25,000.00 a 15% Bid Security of the total bid price must accompany the bid package.**
12. **PERFORMANCE BOND REQUIREMENT:** The Bidder may be required to furnish a Performance Bond on Government Standard Form BB-1 or standby irrevocable Letter of Credit or Certified Check or Cashier's Check payable to the Guam Power Authority issued by any of the local Banks or Bonding Institution in the amount equal to **FIFTEEN PERCENT (15%)** of the contract prices as security for the faithful performance and proper fulfillment of the contract. In the event that any of the provisions of this contract are violated by the contractor, the Chief Procurement Officer shall serve written notice upon both the contractor and the Surety of its intention to terminate the contract. Unless satisfactory arrangement or correction is made within ten (10) days of such notice the contract shall cease and terminate upon the expiration of the ten (10) days. In the event of any such termination, the Chief Procurement Officer shall immediately serve notice thereof upon the Surety. The Surety shall have the right to take over and perform the contract, provided, however, that if the Surety does not commence performance thereof within

10 days from the date of the mailing of notice of termination, the Government may take over and prosecute the same to complete the contract or force account for the account and at the expense of the contractor, and the contractor and his Surety shall be liable to the Government for any excess cost occasioned the Government thereby (GPR Section 3-202.03.4).

- [X] 13. **PERFORMANCE GUARANTEE:** Bidders who are awarded a contract under this solicitation, guarantee that goods will be delivered or required services performed within the time specified. Failure to perform the contract in a satisfactory manner may be cause for suspension or debarment from doing business with the Government and to enforce Section 23 of these General Terms and Conditions. In addition, the Government will hold the Vendor liable and will enforce the requirements as set forth in Section 41 of these General Terms and Conditions.
- [X] 14. **SURETY BONDS:** Bid and Performance Bonds coverage must be signed or countersigned in Guam by a foreign or alien surety's resident general agent. The surety must be an Insurance Company, authorized by the government of Guam and qualified to do business in Guam. Bids will be disqualified if the Surety Company does not have a valid Certificate of Authority from the Government of Guam to conduct business in Guam.
- [X] 15. **COMPETENCY OF BIDDERS:** Bids will be considered only from the such bidders who, in the opinion of the Government, can show evidence of their ability, experience, equipment, and facilities to render satisfactory service.
- [X] 16. **DETERMINATION OF RESPONSIBILITY OF BIDDERS:** The Chief Procurement Officer reserves the right for securing from bidders information to determine whether or not they are responsible and to inspect plant site, place of business; and supplies and services as necessary to determine their responsibility in accordance with Section 15 of these General Terms and Conditions (GPR Section 3-401).
- [X] 17. **STANDARD FOR DETERMINATION OF LOWEST RESPONSIBLE BIDDER:** In determining the lowest responsible offer, the Chief Procurement Officer shall be guided by the following:
- a) Price of items offered.
 - b) The ability, capacity, and skill of the Bidder to perform.
 - c) Whether the Bidder can perform promptly or within the specified time.
 - d) The quality of performance of the Bidder with regards to awards previously made to him.
 - e) The previous and existing compliance by the Bidder with laws and regulations relative to procurement.
 - f) The sufficiency of the financial resources and ability of the Bidder to perform.
 - g) The ability of the bidder to provide future maintenance and services for the subject of the award.
 - h) **The compliance with all of the conditions to the Solicitation.**
- [X] 18. **TIE BIDS:** If the bids are for the same unit price or total amount in the whole or in part, the Chief Procurement Officer will determine award based on Section 3.202.15.2, or to reject all such bids (GPR Section 3-202.15.2).
- [] 19. **BRAND NAMES:** Any reference in the Solicitation to manufacturer's Brand Names and number is due to lack of a satisfactory specification of commodity description. Such preference is intended to be descriptive, but nor restrictive and for the sole purpose of indicating prospective bidders a description of the article or services that will be satisfactory. Bids on comparable items will be considered provided the bidder clearly states in his bid the exact articles he is offering and how it differs from the original specification.
- [X] 20. **DESCRIPTIVE LITERATURE:** Descriptive literature(s) as specified in this solicitation must be furnished as a part of the bid and must be received at the date and time set for opening Bids. The literature furnished must clearly identify the item(s) in the Bid. The descriptive literature is required to establish, for the purpose of evaluation and award, details of the product(s) the bidder proposes to furnish including design, materials, components, performance characteristics, methods of manufacture, construction, assembly or other characteristics which are considered appropriate. Rejection of the Bid will be required if the descriptive literature(s) do not show that the product(s) offered conform(s) to the specifications and other requirements of this solicitation. Failure to furnish the descriptive literature(s) by the time specified in the Solicitation will require rejection of the bid.
- [] 21. **SAMPLES:** Sample(s) of item(s) as specified in this solicitation must be furnished as a part of the bid and must be received at the date and time set for opening Bids. The sample(s) should represent exactly what the bidder proposes to furnish and will be used to determine if the item(s) offered complies with the specifications. Rejection of the Bid will be required if the sample(s) do not show that the product(s) offered conform(s) to the specifications and other requirements of this solicitation. Failure to furnish the sample(s) by the time specified in the Solicitation will require rejection of the Bid.
- [] 22. **LABORATORY TEST:** Successful bidder is required to accompany delivery of his goods with a Laboratory Test Report indicating that the product he is furnishing the Government meets with the specifications. This report is on the bidder's account and must be from a certified Testing Association.
- [X] 23. **AWARD, CANCELLATION, & REJECTION:** Award shall be made to the lowest responsible and responsive bidder, whose bid is determined to be the most advantageous to the Government, taking into consideration the evaluation factors set forth in this solicitation. No other factors or criteria shall be used in the evaluation. The right is reserved as the interest of the Government may require to waive any minor irregularity in bid received. The Chief Procurement Officer shall have the authority to award, cancel, or reject bids, in whole or in part for any one or more items if he determines it is in the public interest. Award issued to the lowest responsible bidder within the specified time for acceptance as indicated in the solicitation, results in a bidding contract without further action by either party. In case of an error in the extension of prices, unit price will govern. It is the policy of the Government to award contracts to qualified local bidders. The government reserves the right to increase or decrease the quantity of the items for award and make additional awards for the same type items and the vendor agrees to such modifications and additional awards based on the bid prices for a period of thirty (30) days after original award. No award shall be made under this solicitation which shall require advance payment or irrevocable letter of credit from the government (GPR Section 3-202.14.1).

- [X] 24. **MARKING:** Each outside container shall be marked with the Purchase Order number, item number, brief term description and quantity. Letter marking shall not be less than 3/4" in height.
- [X] 25. **SCHEDULE FOR DELIVERY:** Successful bidder shall notify the Guam Power Authority, Dededo Warehouse at (671) 653-2073, Information Technology Division at (671) 648-3060, GPA Transportation Supply at (671) 300-8318 and/or Guam Power Authority Cabras Warehouse at (671) 475-3319 at least twenty-four (24) hours before delivery of any item under this solicitation.
- [] 26. **BILL OF SALE:** Successful supplier shall render Bills of Sale for each item delivered under this contract. Failure to comply with this requirement will result in rejection of delivery. The Bill of Sale must accompany the items delivered but will not be considered as an invoice for payment. Supplier shall bill the Government in accordance with billing instructions as indicated on the Purchase Order.
- [] 27. **MANUFACTURER'S CERTIFICATE:** Successful bidder is required, upon delivery of any item under this contract, to furnish a certificate from the manufacturer indication that the goods meet the specifications. Failure to comply with this request will result in rejection of delivery payment. Supplier shall bill the Government in accordance with billing instructions as indicated on the Purchase Order.
- [X] 28. **INSPECTION:** All supplies, materials, equipment, or services delivered under this contract shall be subject to the inspection and/or test conducted by the Government at destination. If in any case the supplies, materials, equipment, or services are found to be defective in material, workmanship, performance, or otherwise do not conform with the specifications, the Government shall have the right to reject the items or require that they be corrected. The number of days required for correction will be determined by the Government.
- [] 29. **MOTOR VEHICLE SAFETY REQUIREMENTS:** The Government will only consider Bids on motor vehicles which comply with the requirements of the National Traffic and Motor Vehicle safety Act of 1966 (Public Law 89-563) and Clean Air Act as amended (Public Law 88-206), that are applicable to Guam. Bidders shall state if the equipment offered comply with these aforementioned Federal Laws.
- [] 30. **SAFETY INSPECTION:** All motor vehicles delivered under this contract must pass the Government of Guam Vehicle Inspection before delivery at destination.
- [X] 31. **GUARANTEE:**
- a) **Guarantee of Vehicle Type of Equipment:**
The successful bidder shall guarantee vehicular type of equipment offered against defective parts, workmanship, and performance, for a period of not less than one (1) year after date of receipt of equipment. Bidder shall also provide service to the equipment for at least one (1) year. Service to be provided shall include, but will not be limited to tune ups (change of spark plugs, contact points and condensers) and lubrication (change of engine and transmission oil). All parts and labor shall be at the expense of the bidder. All parts found defective and not caused by misuse, negligence or accident within the guarantee period shall be repaired, replaced, or adjusted within six (6) working days after notice from the Government and without cost to the Government. Vehicular type of equipment as used in this context shall include equipment used for transportation as differentiated from tractors, backhoes, etc.
- b) **Guarantee of Other Type of Equipment:**
The successful bidder shall guarantee all other types of equipment offered, except those mentioned in 31a, above, against defective parts, workmanship, and performance for a period of not less than three (3) months after date of receipt of equipment. Bidder shall also provide service to the equipment for at least three (3) months. All parts found defective within that period shall be repaired or replaced by the Contractor without cost to the Government. Repairs, adjustments or replacements of defective parts shall be completed by the contractor within six (6) working days after notice from the Government.
- c) **Compliance with this Section is a condition of this Bid.**
- [X] 32. **REPRESENTATION REGARDING ETHICS IN PUBLIC PROCUREMENT:** The bidder or contractor represents that it has not knowingly influenced and promises that it will not knowingly influence a Government employee to breach any of the ethical standards and represents that it has not violated, is not violating, and promises that it will not violate the prohibition against gratuities and kickbacks set forth on Chapter 11 (Ethics in Public Contracting) of the Guam Procurement Act and in Chapter 11 of the Guam Procurement Regulations.
- [X] 33. **REPRESENTATION REGARDING CONTINGENT FEES:** The contractor represents that it has not retained a person to solicit or secure a Government contract upon an agreement or understanding for a commission, percentage, brokerage, or contingent fee, except for retention of bona fide employees or bona fide established commercial selling agencies for the purpose of securing business (GPR Section 11-207).
- [X] 34. **EQUAL EMPLOYMENT OPPORTUNITY:** Contractors shall not discriminate against any employee or applicant of employment because of race, color, religion, sex, or national origin. The contractor will take affirmative action to ensure that employees are treated equally during employment without regards to their race, color, religion, sex, or national origin.
- [X] 35. **COMPLIANCE WITH LAWS:** Bidders awarded a contract under this Solicitation shall comply with the applicable standard, provisions, and stipulations of all pertinent Federal and/or local laws, rules, and regulations relative to the performance of this contract and the furnishing of goods.
- [] 36. **CHANGE ORDER:** Any order issued relative to awards made under this solicitation will be subject to and in accordance with the provisions of Section 6-101-03.1 of the Guam Procurement Regulations.
- [] 37. **STOP WORK ORDER:** Any stop work order issued relative to awards made under this solicitation will be subject to and in accordance with the provisions of Section 6-101-04.1 of the Guam Procurement Regulations.

- [X] 38. **TERMINATION FOR CONVENIENCE:** Any termination order for the convenience of the Government issued relative towards made under this solicitation will be subject to and in accordance with the provisions of Section 6-101.10 of the Government Procurement Regulations.

- [X] 39. **TIME FOR COMPLETION:** It is hereby understood and mutually agreed by and between the contractor and the Government that the time for delivery to final destination or the timely performance of certain services is an essential condition of this contract. If the contractor refuses or fails to perform any of the provisions of this contract within the time specified in the Purchase Order (from the date Purchase Order is acknowledged by vendor), then the contractor is in default. Defaults will be treated subject to and in accordance with the provisions of Section 6-101-08 of the Guam Procurement Regulations.

- [X] 40. **JUSTIFICATION OF DELAY:** Bidders who are awarded contracts under this Solicitation, guarantee that the goods will be delivered to their destination or required services rendered within the time specified. If the bidder is not able to meet the specified delivery date, he is required to notify the Chief Procurement Officer of such delay. Notification shall be in writing and shall be received by the Chief Procurement Officer at least twenty-four (24) hours before the specified delivery date. Notification of delay shall include an explanation of the causes and reasons for the delay including statement(s) from supplier or shipping company causing the delay. The Government reserves the right to reject delay justification if, in the opinion of the Chief Procurement Officer, such justification is not adequate.

- [X] 41. **PAYMENT TERMS:** NET THIRTY (30) DAYS after receipt of ORIGINAL invoice for goods and/or services rendered.

- [X] 42. **LIQUIDATED DAMAGES:** When the contractor is given notice of delay or nonperformance as specified in Paragraph 1 (Default) of the Termination for Default Clause of this contract and fails to cure in the time specified, the contractor shall be liable for damages for delay in the amount of one-fourth of one percent (1%) of outstanding order per calendar day from date set for cure until either the territory reasonable obtains similar supplies or services if the contractor is terminated for default, or until the contractor provides the supplies or services if the contractor is not terminated for default. To the extent that the contractor's delay or nonperformance is excused under Paragraph (4) (Excuse for Nonperformance or Delayed Performance) of the Termination for Default Clause of this contract, liquidated damages shall not be due the territory. The contractor remains liable for damages caused other than by delay (GPR Section 6-101-09.1).

- [X] 43. **PHYSICAL LIABILITY:** If it becomes necessary for the Vendor, either as principal, agent or employee, to enter upon the premises or property of the Government of Guam in order to construct, erect, inspect, make delivery or remove property hereunder, the Vendor hereby covenants and agrees to take, use, provide and make all proper, necessary and sufficient precautions, safeguards and protections against the occurrence of any accidents, injuries or damages to any person or property during the progress of the work herein covered, and to be responsible for, and to indemnify and save harmless the Government of Guam from the payment of all sums of money by reason of all or any such accidents, injuries or damages that may occur upon or about such work, and fines, penalties and loss incurred for or by reasons of the violations of any territorial ordinance, regulations, or the laws of Guam or the United States, while the work is in progress. Contractor will carry insurance to indemnify the Government of Guam against any claim for loss, damage or injury to property or persons arising out of the performance of the Contractor or his employees and agents of the services covered by the contract and the use, misuse or failure of any equipment used by the contractor or his employees or agents, and shall provide certificates of such insurance to the Government of Guam when required.

- [X] 44. **FIXED PRICE:** Pursuant to 2 GAR, Div. 4 §3119 (d) (1) Fixed-Price Contract. A fixed-price contract places responsibility on the contractor for the delivery of the product or the complete performance of the services or construction in accordance with the contracted terms at a price that may be firm or may be subject to contractually specified adjustments. The fixed-price contract is appropriate for use when the extent and type of work necessary to meet territorial requirements can be reasonably specified and the cost can be reasonably estimated, as is generally the case for construction or standard commercial products.

- [] 45. **CONTACT FOR CONTRACT ADMINISTRATION:** If your firm receives a contract as a result of this Solicitation, please designate a person whom we may contact for prompt administration.

Name: _____ Title: _____

Address: _____ Telephone: _____

GOVERNMENT OF GUAM**SEALED BID SOLICITATION INSTRUCTIONS**

1. **BID FORMS:** Each bidder shall be provided with two (2) sets of Solicitation forms. Additional copies may be provided upon request. Bidders requesting additional copies of said forms will be charged per page in accordance with Section 6114 of the Government Code of Guam. All payments for this purpose shall be by cash, certified check or money order and shall be made payable to the Guam Power Authority.
2. **PREPARATIONS OF BIDS:**
 - a) Bidders are required to examine the drawings, specifications, schedule, and all instructions. Failure to do so will be at bidder's risk.
 - b) Each bidder shall furnish the information required by the Solicitation. The bidder shall sign the solicitation and print or type his name on the Schedule. Erasures or other changes must be initialed by the person signing the bid. Bids signed by an agent are to be accompanied by evidence of this authority unless such evidence has been previously furnished to the issuing office.
 - c) Unit price for each unit offered shall be shown and such price shall include packing unless otherwise specified. A total shall be entered in the amount column of the Schedule for each item offered. In case of discrepancies between a unit price and extended price, the unit price will be presumed to be correct.
 - d) Bids for supplies or services other than those specified will not be considered. Time, if stated as a number of days, means calendar days and will include Saturdays, Sundays, and holidays beginning the day after the issuance of a Notice to Proceed. Time stated ending on a Saturday, Sunday or Government of Guam legal holiday will end at the close of the next business day.
3. **EXPLANATION TO BIDDERS:** Any explanation desired by a bidder regarding the meaning or interpretation of the Solicitation, drawings, specifications, etc., must be submitted in writing and with sufficient time allowed for a written reply to reach all bidders before the submission of their bids. Oral explanations or instructions given before the award of the contract will not be binding. Any information given to a prospective bidder concerning a Solicitation will be furnished to all prospective bidders in writing as an amendment to the Solicitation if such information would be prejudicial to uninformed bidders.
4. **ACKNOWLEDGEMENT OF AMENDMENTS TO SOLICITATIONS:** Receipt of an amendment to a Solicitation by a bidder must be acknowledged by signing an acknowledgement of receipt of the amendment. Such acknowledgement must be received prior to the hour and date specified for receipt of bids.
5. **SUBMISSION OF BIDS:**
 - a) Bids and modifications thereof shall be enclosed in sealed envelopes and addressed to the office specified in the Solicitation. The bidder shall show the hour and date specified in the Solicitation for receipt, the Solicitation number, and the name and address of the bidder on the face of the envelope.
 - b) Telegraphic bids will not be considered unless authorized by the Solicitation. However, bids may be modified or withdrawn by written or telegraphic notice, provided such notice is received prior to the hour and date specified for receipt (see paragraph 6 of these instructions).
 - c) Samples of items, when required, must be submitted within the time specified, unless otherwise specified by the Government, at no expense to the Government. If not destroyed by testing, samples will be returned at bidder's request and expense, unless otherwise specified by the Solicitation.
 - d) Samples or descriptive literature should not be submitted unless it is required on this solicitation. Regardless of any attempt by a bidder to condition the bid, unsolicited samples or descriptive literature will not be examined or tested at the bidder's risk, and will not be deemed to vary any of the provisions of this Solicitation.
6. **FAILURE TO SUBMIT BID:** If no bid is to be submitted, do not return the solicitation unless otherwise specified. A letter or postcard shall be sent to the issuing office advising whether future Solicitations for the type of supplies or services covered by this Solicitation are desired.
7. **LATE BID, LATE WITHDRAWALS, AND LATE MODIFICATIONS:**
 - a) Definition: Any bid received after the time and date set for receipt of bids is late. Any withdrawal or modification of a bid received after the time and date set for opening of bids at the place designated for opening is late (Guam Procurement Regulations Section 3-202)
 - b) Treatment: No late bid, late modification, or late withdrawal will be considered unless received before contract award, and the bid, modification, or withdrawal would have been timely but for the action or inaction of territorial personnel directly serving the procurement activity.
8. **DISCOUNTS:**
 - a) Notwithstanding the fact that prompt payment discounts may be offered, such offer will not be considered in evaluating bids for award unless otherwise specified in the Solicitation. However, offered discounts will be taken if payment is made within the discount period, even though not considered in the evaluation of bids.
 - b) In connection with any discount offered, time will be computed from date of delivery and acceptance of the supplies to the destination as indicated in the purchase order or contract. Payment is deemed to be made for the purpose of earning the discount on the date of mailing of the Government check.

9. **GOVERNMENT FURNISHED PROPERTY:** No material, labor or facilities will be furnished by the Government unless otherwise provided for in the Solicitation.
10. **SELLERS' INVOICES:** Invoices shall be prepared and submitted in quadruplicate (one copy shall be marked "original") unless otherwise specified. Invoices shall be "certified true and correct" and shall contain the following information: Contract and order number (if any), item numbers, description of supplies or services, sizes, quantities, unit prices, and extended total. Bill of lading number and weight of shipment will be shown for shipments made on Government bills of lading.
11. **RECEIPT, OPENING AND RECORDING OF BIDS:** Bids and modifications shall be publicly opened in the presence of one or more witnesses, at the time, date, and place designated in the Invitation for Bids. The name of each bidder, the bid price, and such other information as is deemed appropriate by the Procurement Officer, shall be read aloud and recorded, or otherwise made available. The names and addresses of required witnesses shall be recorded at the opening. The opened bids shall be available for public inspection except to the extent the bidder designates trade secrets or other proprietary data to be confidential as set forth in accordance with Section 12 below. Material so designated shall accompany the bid and shall be readily separable from the bid in order to facilitate public inspection of the non-confidential portion of the bid. Prices, makes and models or catalogue numbers of the items offered, deliveries, and terms of payment shall be publicly available at the time of bid opening regardless of any designation to the contrary (Guam Procurement Regulations Section 3-202.12.2).
12. **RESTRICTION AGAINST SEX OFFENDERS:**
5 GCA Section 5253, enacted by P.L. 28-24 and amended by P.L. 28-98:
The service provider warrants that no person in its employment who has been convicted of a sex offense under the provisions of Chapter 25 of Title 9 of the Guam Code Annotated, or of an offense defined in Article 2 of Chapter 28 of Title 9 of the Guam Code Annotated, or who has been convicted of an offense with the same elements as heretofore defined in any other jurisdiction, or who is listed on the Sex Offender Registry shall provide services on behalf of the service provider while on government of Guam property, with the exception of public highways. If any employee of the service provider is providing services on government property and is convicted subsequent to an award of a contract, then the service provider warrants that it will notify the Government of the conviction within twenty-four (24) hours of the conviction, and will remove immediately such convicted person from providing services on government property. If the service provider is found to be in violation of any of the provisions of this paragraph, then the Government will give notice to the service provider to take corrective action. The service provider shall take corrective action within twenty-four (24) hours of notice from the Government, and the service provider shall notify the Government when action has been taken. If the service provider fails to take corrective steps within twenty-four (24) hours of notice from the Government, then the Government in its sole discretion may suspend temporarily any contract for services until corrective action has been taken.
13. **DISABLED VETERAN OWNED:** P.L. 34-115. 5 Guam Code Annotated §5011 & §5012
§5011. Policy In Favor of Service-Disabled Veteran Owned Businesses. Notwithstanding any provision of law, and *except* for the procurement of professional services, if any entity of the government of Guam or any entity expending governmental funds intends to procure any supply or service, which is offered by a business concern that is at least fifty-one percent (51%) owned by a service-disabled veteran(s), that entity *shall* procure such supply or service from that business concern, if the supply or service is available within the period required by procuring entity and the price for the supply or service *does not* exceed one hundred five percent (105%) of the lowest bidder, and *shall* be in addition to any other procurement benefit the service-disabled veteran owned business may qualify for under Guam Law.
§5012. Qualifications of a Service-Disabled Veteran Owned Business. A business concern is qualified under §5011 of this Chapter if:
(a.) the business concern is licensed to do business on Guam;
(b.) the business concern maintains its headquarters on Guam;
(c.) the business concern is at least fifty-one percent (51%) owned by a service-disabled veteran(s) who served in the active U.S. military service, was discharged or released under honorable conditions and whose disability is service-connected as demonstrated by a DD214, and certified by and award letter from the U.S Department of Veterans Affairs;
(d.) the DD214 and Disability award letter from the U.S Department of Veterans Affairs are submitted to the procuring entity for every service offered; and
(e.) the service-disabled veteran(s) owner of the business concern has filed individual tax returns on Guam for a period of *at least* three (3) consecutive years.”
14. **WOMEN-OWNED BUSINESSES:** P.L. 36.26. 5 Guam Code Annotated §5013.
§5013. Policy In Favor of Women-Owned Businesses.
(a.) Notwithstanding any other provision of law, if any entity of the government of Guam or any entity expending governmental funds intends to procure any supply or service which is offered by a business concern that is at least fifty-one percent (51%) owned by women, that entity *shall* procure such supply or service from that business concern, if the supply or service is available within the period required by procuring entity and the price for the supply or service *does not* exceed one hundred five percent (105%) of the lowest bidder, and *shall* be in addition to any other procurement benefit the women-owned business may qualify for under Guam Law. The procuring entity shall determine the lowest price to the entity in the case of more than one (1) women-owned business, or a women-owned business and a service-disabled veteran owned business, who are competing for the same government contract
(b.) Qualifications of a Women-Owned Business. A business concern is qualified under Subsection (a) of the Section if:
(1) the business concern is licensed to business on Guam;
(2) the business concern maintains its headquarters on Guam;

- (3) the business concern is at least fifty-one percent (51%) owned by women, who manage day-to-day operations and make long-term decisions;
- (4) the business concern is certified as a Women-Owned Small Business (WOSB) or an Economically Disadvantaged Women-Owned Small Business (EDWOSB) by the U.S. Small Business Administration; and
- (5) the owner(s) of the business concern has (have) filed individual tax returns on Guam for a period of at least three (3) consecutive years

15. **CONFIDENTIAL DATA:** The Procurement Officer shall examine the bids to determine the validity of any requests for nondisclosure of trade secrets and other proprietary data identified in writing. If the parties do not agree as to the disclosure of data, the Procurement Officer shall inform the bidders in writing what portions of the bid will be disclosed and that, unless the bidders protest under Chapter 9 of the Guam Procurement Act (P.L. 16-124), the bids will be so disclosed. The bids shall be opened to public inspection subject to any continuing prohibition on the disclosure of confidential data (Guam Procurement Regulations Section 3-202.12.3).

16. **MULTI-STEP SEALED BIDDING:**

- a. It is defined as two-phase process consisting of a technical first-phase composed of one or more steps in which bidders submit unpriced technical offers to be evaluated by the territory, and a second-phase in which those bidders whose technical offers are determined to be acceptable during the first-step have their priced bids considered. It is designed to obtain the benefits of competitive sealed bidding by award of a contract to the lowest responsive, responsible bidder, and at the same time obtained the benefits of the competitive sealed proposals procedure through the solicitation of technical offers and the conduct of discussions to evaluate and determine the acceptability of technical offers.
- b. In addition to the requirements set forth in the General Terms and Conditions and the Special provisions, the following applies:
 - 1). only unpriced technical offers are requested in the first phase;
 - 2). priced bids will be considered only in the second phase and only from bidders whose unpriced technical offers are found acceptable in the first phase;
 - 3). the criteria to be used in the evaluation at those specified in the Special Provisions and the General Terms and Conditions;
 - 4). the territory, to the extent the Procurement Officer finds necessary, may conduct oral or written discussion of the unpriced technical offers;
 - 5). the bidders, may designate those portions of the unpriced technical offers which contain trade secrets or other proprietary data which are to remain confidential; and,
 - 6). the service being procured shall be furnished generally in accordance with bidder's technical offer as found to be finally acceptable and shall meet the requirements of the Invitation for Bids.
- c. **RECEIPT AND HANDLING OF UNPRICED TECHNICAL OFFERS.**
Unpriced technical offers shall not be opened publicly, but shall be opened in front of two or more procurement officials. Such offers shall not be disclosed to unauthorized persons. Bidders may request nondisclosure of trade secrets and other proprietary data identified in writing.
- d. **EVALUATION OF UNPRICED TECHNICAL OFFERS.**
The unpriced technical offers submitted by bidders shall be evaluated solely in accordance with the criteria set forth in the Invitation for Bids. The unpriced technical offers shall be categorized as:
 - 1). acceptable;
 - 2). potentially acceptable, that is, reasonably susceptible of being made acceptable; or
 - 3). unacceptable. The Procurement Officer shall record in writing the basis for finding an offer unacceptable and make it part of the procurement file.

The Procurement Officer may initiate Phase Two of the procedure if, in the Procurement Officer's opinion, there are sufficient acceptable unpriced technical offers to assure effective price competition in the second phase without technical discussions. If the Procurement Officer finds such is not the case, the Procurement Officer shall issue an amendment to the Invitation for Bids or engage in technical discussions as set forth in Subsection 3-202.20.5 of this Section.

- e. Upon the completion of Phase One, the Procurement Officer shall invite each acceptable bidder to submit a price bid. Upon submission of prices, the Procurement Officer shall prepare the final evaluation and reconsideration for the Chief Procurement Officer's approval.